

LEISURE'S EDGE

HOT TUB OWNER'S MANUAL

MODELS: LE852, LE851, LE850, LE 744, LE742,
LE630



Premium Leisure, LLC
6101 45th St. N.
St. Petersburg, FL 33714
727.573.9611
www.PremiumLeisure.com

Part Number 7652
(SKUs: 1404, 1405, 1406, 1407, 1408, 1409)
Revised 03/2015

Owner's Information

Dealer:

Date Purchased: _____
Company: _____
Address: _____
Telephone: _____

Installer:

Date Installed: _____
Company: _____
Address: _____
Telephone: _____

Hot Tub:

Date Delivered: _____
Model: _____
Color: _____
Serial Number: _____

Your unique hot tub serial number is located on a data plate outside the cabinet at ground level directly below the topside control panel. When calling for service, have your serial number in hand.



Serial Number Location

Leisure's Edge™ Hot Tub Owner's Manual

Table of Contents

Introduction	2
Important Safety Information	3
Site Selection, Installation & Wiring.....	8
Startup.....	21
Water Balancing	24
Topside Controls & Operation	29
Stereo System.....	32
Cover.....	33
Frequently Asked Questions	34
Troubleshooting	38
Maintenance & Care.....	42
Specifications	46

Important: Premium Leisure is dedicated to offering you the best in customer satisfaction and service. Be sure to read, complete, sign, and **send in the limited warranty card within 30 days of purchase or register online at <http://premiumleisure.com/owners.shtml>** to ensure you understand what you are entitled to in terms of service. If you have any questions, you can call our customer care center at 727.573.9611.

Printed in the U.S.A.

Version 2.1

Revised 3/2015

Part Number 7652

Patent # D694895

Copyright © 2011, Premium Leisure LLC. All rights reserved. No portion of this manual may be reproduced in any manner without express written permission of Premium Leisure LLC. Leisure's Edge™ Hot Tubs and Thermazone™ are trademarks of Premium Leisure LLC. All other brands, product names, company names, trade names, trademarks, and service marks used are the property of their respective owners. Premium Leisure LLC may make product modifications and enhancements. Specifications may change without notice. International products may be configured differently to meet local electrical requirements. Dimensions are approximate..

Introduction

LEISURE'S EDGE

Your choice of a Leisure's Edge™ brand hot tub from Premium Leisure LLC indicates that you are devoted to excellence. The management and staff appreciate your patronage and takes pride in the tradition of quality hot tubs that our company represents.

To properly acquaint yourself with your hot tub, we suggest that you take time to read through this manual before hook up and operation. Doing so will familiarize you with important operating and safety procedures, thereby ensuring an enjoyable experience right from the start.

If you need any more information than this manual provides, feel free to visit our Web site at www.PremiumLeisure.com or call our customer care center, at 727.573.9611.

⚠ WARNING: This manual was written to ensure the proper use and installation of your hot tub. Any modifications to the procedures outlined in this manual may result in voiding your warranty.

This manual and its contents are subject to change without notice. Although we have prepared this manual as accurate as possible, we are not liable for errors or omissions; loss, injury, or damages caused by improper installation; or use of hot tub (improper or otherwise).

Your new hot tub is made with quality synthetic cabinet materials. Synthetic materials won't fade and are nearly invulnerable to mold and mildew. Where wood splits, cracks, and stains, synthetic materials stand in timeless perfection.

Important Safety Information

IMPORTANT SAFETY INSTRUCTIONS SAVE THESE INSTRUCTIONS

Your physiological response to hot water depends on subjective factors such as age, health, pregnant women, temperature sensitivities, chemical sensitivities, and medical history. Always consult a physician before using a hot tub to understand your particular tolerance and limitations.

READ AND FOLLOW ALL INSTRUCTIONS





WARNING – To reduce the risk of injury, do not permit children to use this product unless they are closely supervised at all times.

A wire connector is provided on this unit to connect a minimum 8 American Wire Gauge (AWG) (8.4mm²) solid copper conductor between this unit and any metal equipment, metal enclosures of electrical equipment, metal water pipe, or conduit within 5 feet (1.5 m) of the unit.

*** For cord connected / convertible units:**  **Danger – Risk of injury.**
Replace damaged cord, immediately. Do not bury cord. Connect to a grounded, grounding type receptacle only.













**** For units with GFCI:**  **Warning** – This product is provided with a ground-fault circuit interrupter located in the main panel. The GFCI must be tested before each spa use.

Dangers

-  **RISK OF ACCIDENTAL DROWNING:** Extreme caution must be exercised to prevent unauthorized access by children. To avoid accidents, ensure that children cannot use this spa unless they are supervised at all times. Always cover the hot tub and use safety locks when it is not in use.
-  **RISK OF INJURY:** The suction fittings in this spa are sized to match the specific water flow created by the pump. Should the need arise to replace the suction fittings or the pump, be sure that the flow rates are compatible. Never operate the spa if the suction fittings are broken or missing. Never replace a suction fitting with one rated less than the flow rate marked on the original suction fitting.
-  **RISK OF ELECTRIC SHOCK:** Install at least 5 feet (1.5 m) from all metal surfaces. As an alternative, a spa may be installed within 5 feet of metal surfaces if each metal surface is permanently connected by a minimum 8 AWG (8.4 mm²) solid copper conductor to the wire connector on the terminal box that is provided for this purpose.
-  **RISK OF ELECTRIC SHOCK:** Do not permit any electric appliance, such as a light, telephone, radio or television, within 5 feet (1.5 m) of a spa. Do not operate such an appliance from either inside the hot tub or when you are wet, unless such appliances are built-in by the manufacturer.

Warnings

TO REDUCE THE RISK OF INJURY:

- The water in a spa should never exceed 40°C (104°F). Water temperatures between 38°C (100°F) and 40°C (104°F) are considered safe for a healthy adult. Lower water temperatures are recommended for young children and when spa use exceeds 10 minutes.
 - Since excessive water temperatures have a high potential for causing fetal damage during the early months of pregnancy, pregnant or possible pregnant women should limit spa water temperatures to 38°C (100°F).
 - Before entering a spa/hot tub, the user should measure the water temperature since the tolerance of water temperature regulating devices varies.
 - The use of alcohol, drugs or medication before or during spa/hot tub use may lead to unconsciousness with the possibility of drowning.
 - Obese persons and persons with a history of heart disease, low or high blood pressure, circulatory system problems, or diabetes should consult a physician before using a spa.
 - Persons using medication should consult a physician before using a spa/hot tub since some medication may include drowsiness while other medication may affect heart rate, blood pressure and circulation.
-  Do not connect auxiliary components (such as headphones, cables, and additional speakers) to the stereo (if equipped).
-  Do not use a hot tub immediately following strenuous exercise.
-  Do not use your hot tub alone.
-  Lock the cover on your hot tub when not in use.
-  Persons with infectious diseases should not use a hot tub.
-  Replace audio components only with identical components.
-  Do not leave the CD access door open on the stereo (if equipped).
-  Some types of hair dye can react with the sanitizers in your hot tub water causing your hair to change color. Use at your own risk.
-  Water normally splashes out of a hot tub during typical use. Install an adequate perimeter that provides sound footing.
-  Do not turn your hot tub on/off from a wall switch, ground fault circuit interrupter, circuit breaker, fuse, or by plugging/unplugging it.
-  Remove all jewelry, metal, and watches from your person before entering your hot tub.
-  Keep all breakables away from the hot tub area.
-  Maintain water balance in accordance with instructions.

Warning Sign



Warning Sign Must Be Posted – The red WARNING sign like the one shown is packed with your new hot tub. This sign must be posted in a prominent place in close proximity to the hot tub installation site immediately upon completion of hot tub installation.

Important: It is extremely important that this sign be permanently placed in clear view of persons using the hot tub. Occasional hot tub users may not be aware of some of the dangers hot water poses to pregnant women, small children, seniors, and people under the influence of alcohol. If you did not receive a warning sign or your sign has become damaged, please call your local dealer for a replacement.

Hyperthermia

To reduce the risk of injury, the water temperature in a hot tub should never exceed 104°F (40°C). Water temperatures between 100°F (38°C) and 104°F (40°C) are considered safe for a healthy adult. Lower water temperatures are recommended for young children, senior citizens, persons with sensitivities, and when hot tub use exceeds 10 minutes.

WATER TEMPERATURE IN EXCESS OF 100°F (38°C) MAY BE INJURIOUS TO YOUR HEALTH.

Hyperthermia occurs when the internal temperature of the body reaches a level several degrees above the normal body temperature of 98.6°F (37°C). The symptoms of hyperthermia include drowsiness, lethargy, and an increase in the internal temperature of the body. The effects of hyperthermia include:

- ⚠ Unawareness of impending hazard
- ⚠ Failure to perceive heat
- ⚠ Failure to recognize the need to exit hot tub
- ⚠ Physical inability to exit hot tub
- ⚠ Fetal damage in pregnant women
- ⚠ Unconsciousness and danger of drowning

If you sense any of the symptoms of hyperthermia, safely exit the hot tub immediately.

SAVE THESE INSTRUCTIONS

Basic Safety Guidelines

Your hot tub is meant to be enjoyable, healthful, and relaxing. Below are some basic safety guidelines to follow every time you use your hot tub.

- Always check the temperature of your hot tub before entering. High water temperatures can be hazardous to your health.
- Persons suffering from heart disease, diabetes, high or low blood pressure, and pregnant women should consult a doctor before using your hot tub.

- Persons under the influence of medication, drugs, or alcohol should not be allowed into your hot tub.
 - Remove all jewelry, metal, and watches from your person before entering your hot tub.
 - Do not allow children to use your hot tub without continuous supervision of an adult.
 - Do not use your hot tub alone.
 - Test the ground fault circuit interrupter (GFCI) breaker prior to using your hot tub each time to ensure it operates properly.
 - Any electrical devices near your hot tub must be GFCI protected and out of reach from inside the hot tub.
 - Keep all breakables away from the hot tub area.
 - Lock the cover on your hot tub when not in use.
 - Enter and exit the hot tub slowly. Wet surfaces can be slippery.
 - Prolonged immersion can be hazardous to your health.
- Maintain water chemistry in accordance with manufacturer's instructions.
- The hot tub is not to be used by persons with reduced physical, sensory or mental capabilities, or lack of experience and knowledge, unless they have been given supervision or instruction

Basic Water Quality Guidelines

- *During the initial filling of the spa, add a sequestering agent to combat suspended minerals in the water. Allow water to circulate and filter for at least 12 hours before adding any other chemicals.*
- *Test water for PH, total Alkalinity, and Calcium hardness. The PH should be 7.2-7.8 and the total Alkalinity 80-180 PPM. Calcium hardness levels should be maintained between 150 and 400 PPM. Adjust PH and total Alkalinity (TA) utilizing the directions on the chemical bottles. Wait 15-30 minutes, test and adjust if necessary.*
- *Add 2 ounces of concentrated chlorinating granules (sodium Dichlor-s-triazinetreone) on initial start up to begin sanitizing the spa water. It is important not to add the chlorinating granules until the PH, alkalinity and calcium hardness have been adjusted to their proper levels.*
- *Check spa water with test strip for proper sanitation levels and adjust accordingly to the proper levels. Free chlorine should be 2-4 PPM.*
- *We recommend a minimum level of 2 PPM residual chlorine be maintained in spa water. Be sure the pumps are running when adding chlorine or non chlorine shock/oxidizer.*
- *Add 1 ounce of non-chlorine shock/oxidizer or ½ ounce of chlorine to the spa water after each spa use.*

For Hot Tubs Equipped with Audio Components

Audio components are optional and not available on all models.

⚠ WARNING: Prevent Electrocutation: Do not connect any auxiliary components – for example, cable, additional speakers, headphones, etc., – to the system.

⚠ Caution: Risk of Electric Shock: Do not leave audio compartment door open. Replace audio components only with identical components.



Site Selection, Installation & Wiring

Proper planning is an important consideration when installing your new hot tub. Site selection is a critical step and requires serious thought. Planning ahead makes the installation process easier. The following information is provided to assist you in site preparations.

- 1) Always comply with local building codes and obtain any necessary permits. You may also need to consult with an engineer to address your specific design needs.
- 2) Contact an electrician to assess your electrical needs, install wiring, and assure a safe operation.
- 3) Position your hot tub with proper access to water, drainage, and electricity.
- 4) Place your hot tub on a uniform solid, flat surface designed to properly support its weight. For external installations, a 4-inch (10 cm) thick cement pad suffices. See page 9 for conduit entry locations for your model hot tub.
- 5) For internal installations, check the load carrying capabilities of the floor on which the hot tub will reside. Most homes meet the requirement of 80 pounds per square foot.
- 6) Assure that your hot tub will fit into the space you have chosen and the delivery route will accommodate its large size.
- 7) Provide adequate ventilation for the humidity created by your hot tub. In most cases, a Hot Tub Hard Cover is sufficient.
- 8) Protect the pump and all equipment from the weather by ensuring the cabinet panels are secure at all times.
- 9) Allow 36 inches (1 meter) of unobstructed access to all sides of your hot tub for normal servicing. Your hot tub is not designed to be recessed in the ground or in a deck.

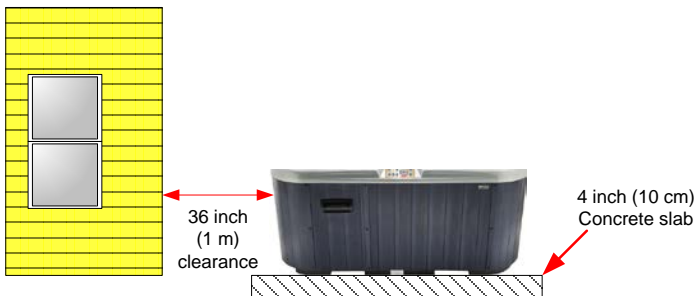

Figure 1 – Clearances and Support

The following dimensions can be used to determine the proper location of submerged conduits in concrete slab installations. All dimensions are made from the outside of the hot tub's frame with the access panels removed. The topside control panel is shown at bottom of diagram for reference.

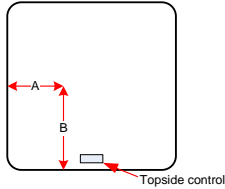

Figure 2 – Conduit Entry Location Reference Points

Model	Dimension A	Dimension B
LE 852	24" (61 cm)	11" (28 cm)
LE 850	24" (61 cm)	11" (28 cm)
LE 851	24" (61 cm)	11" (28 cm)
LE 744	25" (63.5 cm)	11" (28 cm)
LE 742	25" (63.5 cm)	11" (28 cm)
LE 630	16" (40.5 cm)	13" (33 cm)

Table 1 – Conduit Entry Location Dimensions

- 10) Consider positioning your hot tub out of or adequately protecting it from the wind. Just as people can get cold on cool/windy days, so can your hot tub. Windy environments can significantly increase operating costs.
- 11) Consider using an insulating pad. In cold climates, the ground can rob heat from the hot tub and increase your operating costs.

Electrical Specifications

Important – Qualified and licensed electricians must perform all electrical hookups in accordance with the National Electric Code. The following specifications must be followed in order to ensure proper performance & safety.

⚠ WARNING: Starting an incorrectly wired hot tub could cause severe damage to the mechanical equipment or even bodily harm. Have your licensed electrician verify GFCI (or RCD) wiring with the diagrams on pages 11-20 prior to starting the hot tub or call the technical support line at 727.573.9611.

⚠ Caution: Failure to abide by specifications listed may result in damage to the equipment and will void the warranty.

All hot tubs must be wired with the appropriately sized wiring. Failure to do so will cause equipment damage and will not be covered under your warranty.

All hot tubs must be over current protected with a built-in GFCI (or RCD) in the service panel.

Model	Volts (V)	Freq. (Hz)	Rating (A)	GFCI (A)	Wire size from GFCI to Main Panel†	Equipment Pack
LE 852, LE 850, LE 744, LE 742, LE 851	240	60	48	60	6-3 plus ground (up to 130') 4-3 plus ground (up to 230') 2-3 plus ground (up to 360')	VS510SZ or BP501X, TP600CE*
LE 630	240	60	40	50	"	VS500Z or BP501X, TP600CE*

Table 2 – Domestic Wire Size Chart

Model	Volts (V)	Rating (A)	RCD (A)	Wire size from RCD to Main Panel‡§	Equipment Pack
LE 852, LE 850, LE 744, LE742, LE 630,LE 851	220- 240	1x32 2x16	IEE Wire Regulation	3x4 mm ² 5x1.5 mm ²	GS510SZ or BP601X, TP600CE*

Table 3 – Export (Overseas) Wire Size Chart

*For Spas with TP600CE see included 7876A insert.

* Wire size may need to be reduced at GFCI to fit into the breaker

† Solid copper

‡ Wire size may need to be reduced at GFCI to fit into the breaker

§ Solid copper

⚠ WARNING: Disconnect electrical power before servicing. Before obtaining access to terminals, all supply circuits must be disconnected.

⚠ WARNING: Test the GFCI (or RCD) before each use.



Our hot tubs are certified by Intertek Testing, SNAa Ltd. Ontario, Canada to CSA-C22.2 No. 218.1-M89 and ANSI/UL 1563 standards.



Parts with extra low voltage not exceeding 12v must be inaccessible to a person in the hot tub. Earthed appliances must be permanently connected to fixed wiring. Parts incorporating electrical components, except remote control devices, must be located or fixed so that they cannot fall into the hot tub.

Means for disconnection must be used in fixed wiring in accordance with wiring rules.

Important – To allow the 240V GFCI to function properly, connect the white Neutral wire from the hot tub to the Neutral terminal on the GFCI breaker, not the Neutral bus in the GFCI breaker box. An improperly connected Neutral causes the GFCI breaker to trip.

Wiring Diagrams

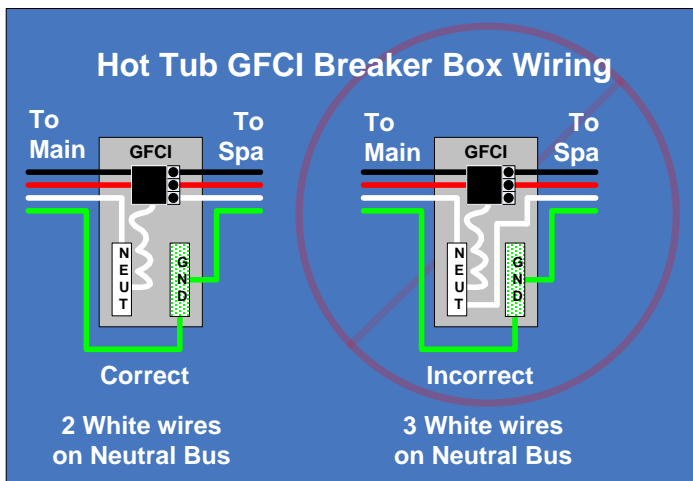
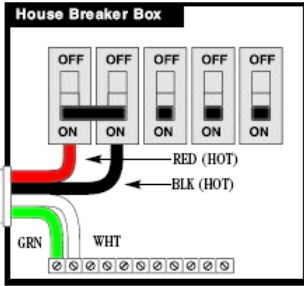

Figure 3 – 240V GFCI Wiring

The following diagrams and information show how to properly wire your new Leisure's Edge hot tub.



Important: Installation of this GFCI Circuit Breaker, including Ampere sizing and selection of conductor size and type, must be performed by a qualified electrician in accordance with the National Electrical Code, or the Canadian Electrical Code, and all federal, state, and local codes and regulations in effect at the time of installation.

Note: The white Neutral wire from the back of the GFCI must be connected to the incoming Line Neutral. The internal mechanism of the GFCI requires this neutral connection. The GFCI will not work without it.

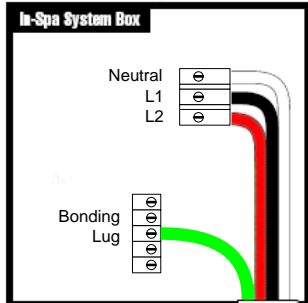
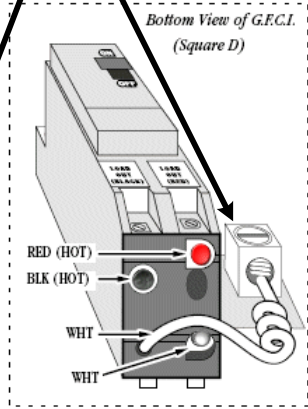
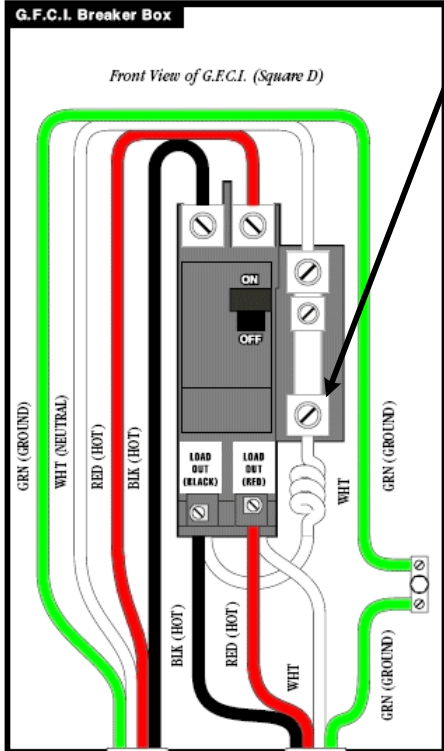

Figure 4 – U.S. and Canada Wiring Diagram

See wire size chart on page 10.

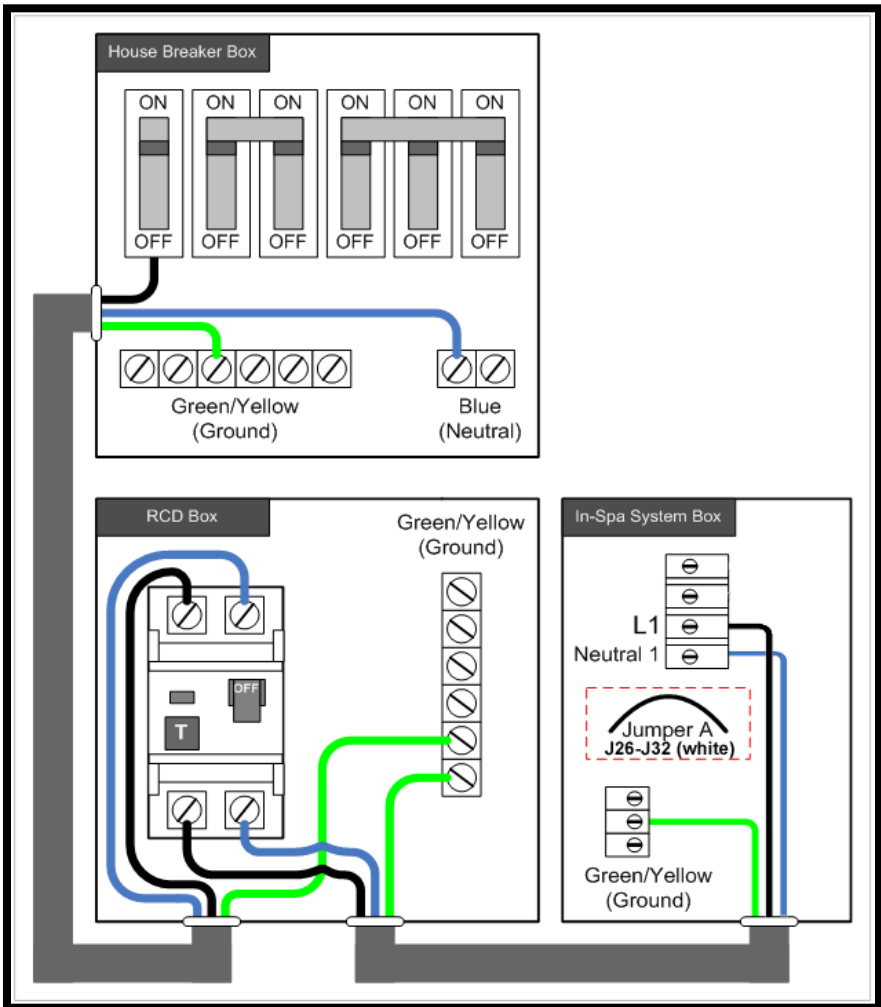

Figure 5 – European 1x32A Wiring Diagram

All wiring is 3x4 mm², solid copper
See wire size chart on page 10.

Note: Make sure that the DIP switches in the hot tub Pack are properly set for 50Hz operation and Jumper A is in place.

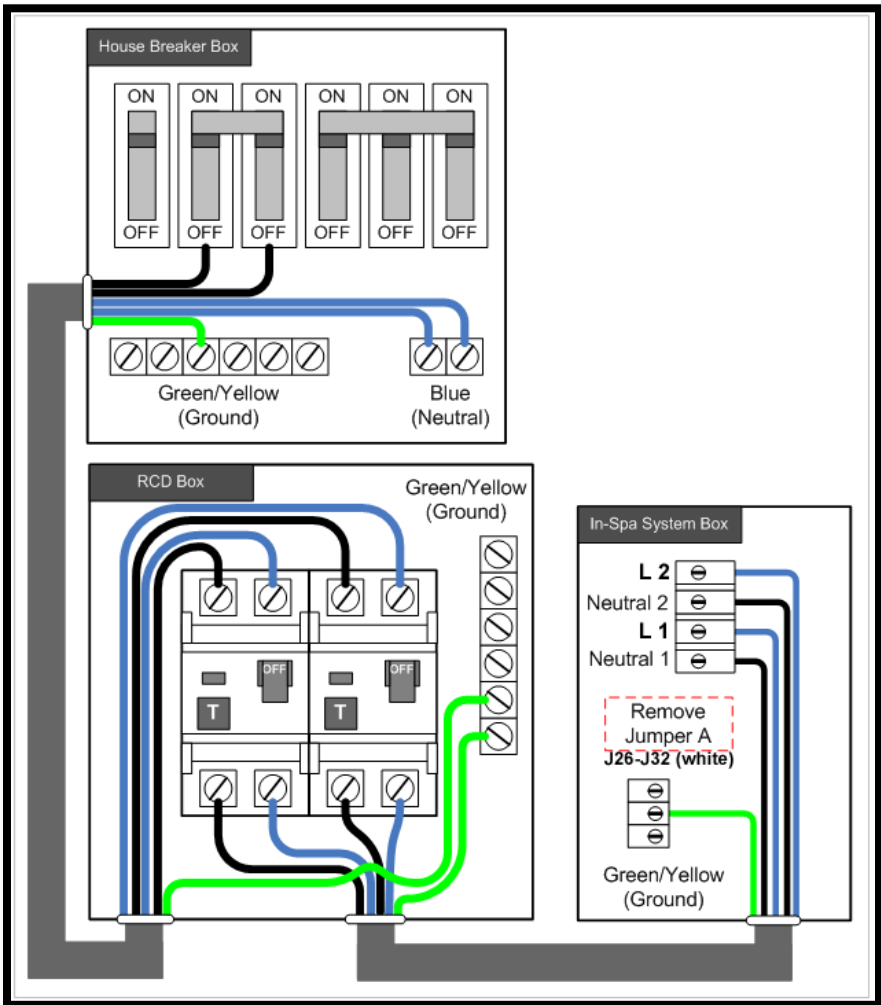

Figure 6 – European 2x16A Wiring Diagram

All wiring is 5x 1.5 mm², solid copper
See wire size chart on page 10.

Note: Make sure that the DIP switches in the hot tub Pack are properly set for 50Hz operation and Jumper A is removed.

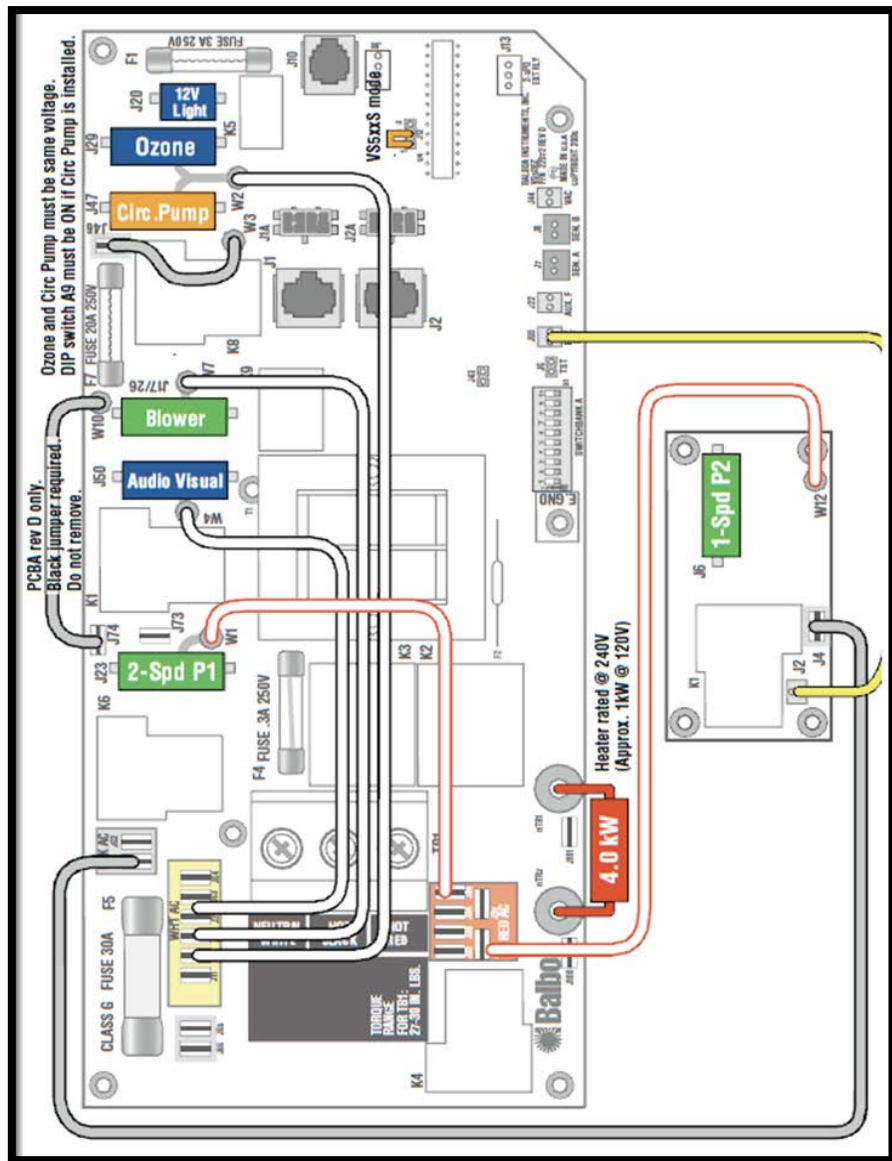

Figure 7 – Domestic Wiring Diagram for LE 852, LE 850, LE 744, LE 851 and LE 742 Models Single-phase 240V with VS510SZ Control Pack.

See wire size chart on page 10.

WARNING: Main Power to system should be turned OFF BEFORE adjusting DIP switches.
WARNING: Persistent Memory (J43) must be RESET to allow new DIP switch settings to take effect.

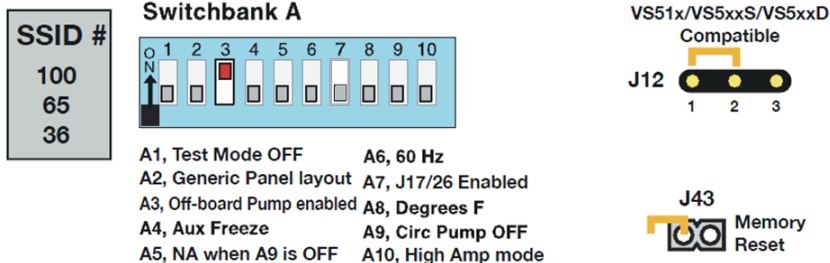
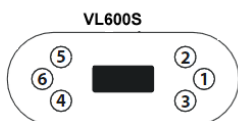

Figure 8 – Board Diagram for LE 852, LE 851, LE 850, LE 744 and LE 742 Models Single-phase 240V Domestic version

WARNING:

- Setting DIP switches incorrectly may cause abnormal system behavior and/or damage to system components.
- Refer to Switchbank illustration on Wiring Configuration page for correct settings for this system.



Panel Button Assignments (A2 must be OFF)

- 1=Mode
- 2=Temp Up
- 3=Temp Down
- 4=Light
- 5=Pump 1
- 6= Pump 2

Figure 9 – Panel Button Positions for LE 852, LE 851, LE 850, LE 744 and LE 742 Models Single-phase 240V Domestic version

SSID 100 65 36

Base Model VS500SZ-VS501SZ-VS510SZ

DIP Switch Key

- A1 Test Mode (normally OFF)
- A2 "ON" position: Long Serial Standard panel (customer specific)
"OFF" position: Generic Balboa Serial Standard panel layout
- A3 "ON" position: off-board pump enabled *
"OFF" position: off-board pump disabled
- A4 Aux Freeze (must be OFF)
- A5 Disabled when A9 is OFF
"ON" position: Two-speed pump 1
"OFF" position: One-speed pump 1 (A9 must be On and a Circ Pump installed)
- A6 "ON" position: 50Hz operation
"OFF" position: 60Hz operation
- A7 "ON" position: J17/26 equipment enabled *
"OFF" position: J17/26 equipment disabled
- A8 "ON" position: temperature is displayed in degrees Celsius
"OFF" position: temperature is displayed in degrees Fahrenheit
- A9 "ON" position: 24 Hour Circ Pump with 3°F shut off, Ozone runs with Circ Pump
"OFF" position: no Circ Pump, Ozone runs with Pump 1-low during filter cycles only
- A10 "ON" position: heater is disabled while any high-speed pump or blower is running (low amperage mode)
"OFF" position: heater can run while any/all high-speed pumps or blowers are running (high amperage mode)

* Panel with button layout  is not compatible when both A3 and A7 are ON.

Jumper Key

- J12** Jumper on Pin 1 and 2 will enable VS51x/VS5xxS/VS5xxD compatibility mode.
Jumper on Pin 2 and 3 will enable VS50x compatibility mode (Do not use with Standard or Deluxe Panels).
 - J43** When jumper is placed on 2 pins during power-up, system will reset persistent memory.
Leave on 1 pin only to enable persistent memory feature.
-

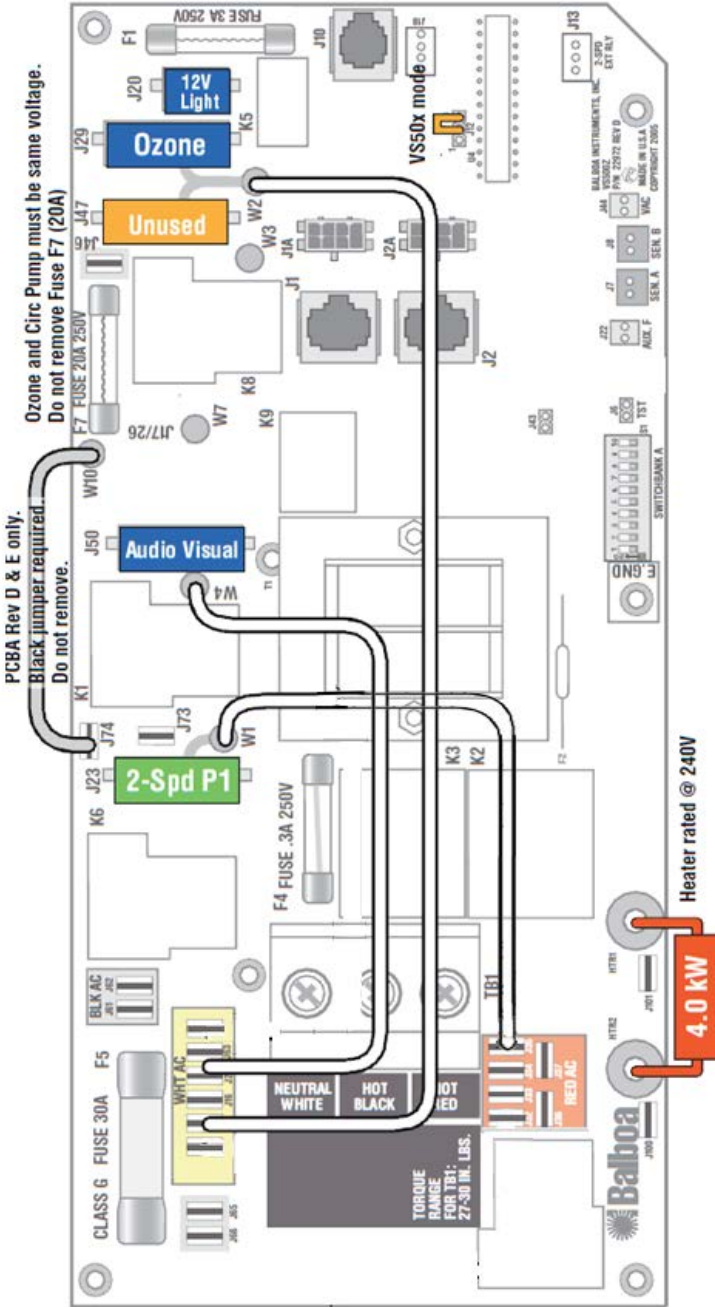

Figure 10 – Domestic Wiring Diagram for LE 630 Model Single-phase 240V for VS500Z Control Pack.

WARNING: Main Power to system should be turned OFF BEFORE adjusting DIP switches.
WARNING: Persistent Memory (J43) must be RESET to allow new DIP switch settings to take effect.

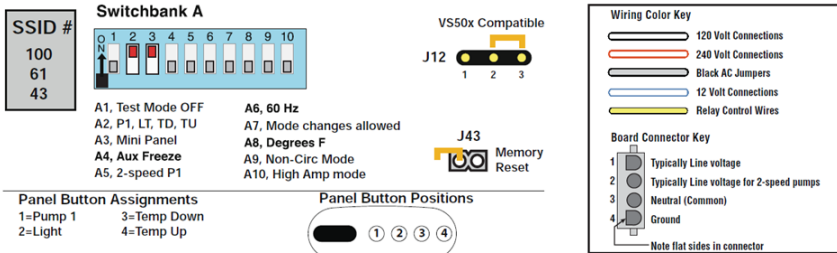

Figure 11 – Board Diagram for LE 630 Model Single-phase 240V Domestic version

SSID 100 61 43

Base Model VS500Z

DIP Switch Key

- A1 Test Mode (normally OFF)
- A2 "ON" position: Button layout will be: Pump 1, Light, Temp Down, Temp Up *
 "OFF" position: Button layout will be: Unused, Pump 1, Temp, Light
- A3 "ON" position: use Mini Panel
 "OFF" position: use Lite Duplex or Digital Duplex panel
- A4 Aux Freeze (must be OFF)
- A5+A9 Pump 1 speeds and Circ Modes:

A5	A9	Circ Mode	Pump 1 Speed
OFF	OFF	Non-circ	2-speed
ON	OFF	Circ "acts like Pump 1 low" (filters/polls/act)	1-speed
OFF	ON	24 hours with 3°F shut-off	1-speed
ON	ON	24 hours with 3°F shut-off	2-speed
- A6 "ON" position: 50Hz operation
 "OFF" position: 60Hz operation
- A7 "ON" position: Standard mode only
 "OFF" position: Std/Ecn/Sleep mode changes allowed
- A8 "ON" position: temperature is displayed in degrees Celsius
 "OFF" position: temperature is displayed in degrees Fahrenheit
- A10 "ON" position: heater is disabled while any high-speed pump is running (low amperage mode)
 "OFF" position: heater can run while any/all high-speed pumps are running (high amperage mode)

Jumper Key

- J12 **Factory set. DO NOT MOVE.**
 Jumper must be on Pins 1 and 2 for VS51xZ/VS52xZ/VS5xxZ/VS5xxDZ software.
 Jumper must be on Pins 2 and 3 for VS50xZ software.
- J43 When jumper is placed on 2 pins during power-up, system will reset persistent memory.
 Leave on 1 pin only to enable persistent memory feature.

Export Wiring LE 852, LE 851, LE 850, LE 744, LE 742, LE 630

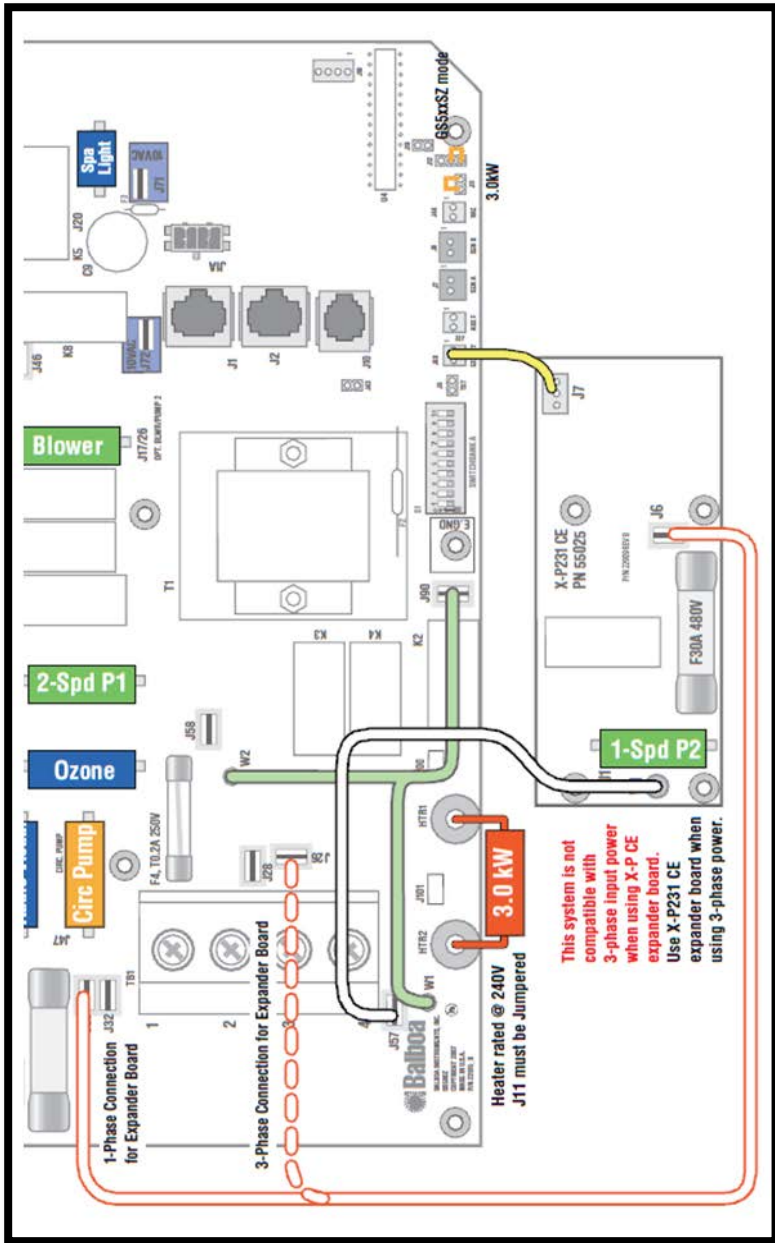

Figure 12 – Export Wiring Diagram for LE 852, LE 851, LE 850, LE 744, LE 742 & LE 630 Models for GS510SZ Control Pack (See wire size chart on Pg. 10.)

WARNING: Main Power to system should be turned OFF BEFORE adjusting DIP switches.
WARNING: Persistent Memory (J43) must be RESET to allow new DIP switch settings to take effect.

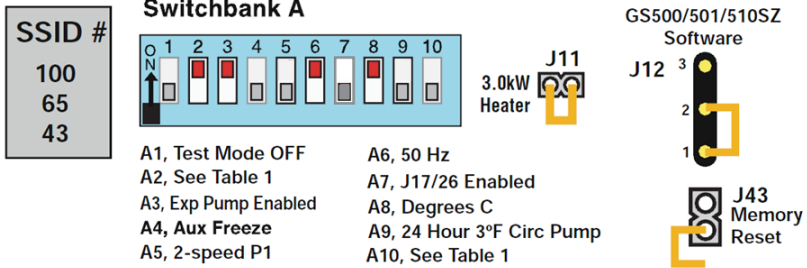

Figure 13 – Board Diagram for LE 852, LE 851, LE 850, LE 742, LE 744 and LE 630 Models. Export version for GS510SZ Control Pack.

SSID 100 65 43 Base Model GS500SZ-GS501SZ-GS510SZ

DIP Switch Key

- A1 Test Mode (normally OFF)
- A2+A10 Control amp draw requirements (See Table 1)
- A3 "ON" position: Expander Board Enabled for 1-speed Pump only.*
"OFF" position: Expander Board Disabled.
- A4 Aux Freeze (must be OFF)
- A5+A9 Pump 1 speeds and Circ Modes:

A5	A9	Circ Mode	Pump 1 Speed
OFF	OFF	Non-circ	2-speed
ON	OFF	Circ "acts like Pump 1 low" (filters/polls/ect)	1-speed
OFF	ON	24 hours with 3°F shut-off	1-speed
ON	ON	24 hours with 3°F shut-off	2-speed

Table 1		# of Hi-Speed Pumps/Blower Before Heat Disabled
A2	A10	
OFF	OFF	0
ON	OFF	1
OFF	ON	2
ON	ON	3

- A6 "ON" position: 50Hz operation
"OFF" position: 60Hz operation
 - A7 "ON" position: J17/26 Enabled for Blower or 1-speed Pump.*
"OFF" position: J17/26 Disabled
 - A8 "ON" position: temperature is displayed in degrees Celsius
"OFF" position: temperature is displayed in degrees Fahrenheit
- * Panel with button layout (Ⓜ Ⓜ) is not compatible when both A3 and A7 are ON.

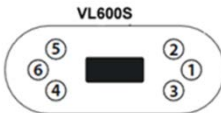

Panel Button Assignments (A2 must be OFF)

- 1=Mode
- 2=Temp Up
- 3=Temp Down
- 4=Light
- 5=Pump 1
- 6= Pump 2

Figure 14 – Panel Button Positions for LE 852, LE 851, LE 850 and LE 742, LE 744 Models Export version.

Startup

Important – Read these step-by-step startup procedures before starting your hot tub. Failure to follow any of these steps listed may result in damage to the equipment and may void your warranty.

Note: If you are unsure of any of the above startup procedures, please call our customer care center at 727.573.9611. For best results, read each step in its entirety before proceeding.

⚠ Caution: Running the hot tub pump dry (without water running through it) can cause IMMEDIATE damage and will void the warranty! Be sure that the hot tub is installed properly in accordance with the instructions in this manual.

Refer to the following picture for an explanation of your hot tub's controls, components, and technical terms. Note that not all models have all features and components.

Before Adding Water

Before adding water, go through these simple steps now to prevent common issues when setting up your hot tub for the first time. Verify that the following have all been rechecked.

1. Turn off all power to the hot tub at the main breaker panel.
2. Open the side panels to access the internal components.
3. Check that all slide valves are opened (T-handles pulled out) to the heater and all pumps.
4. Check that there are no obvious signs of loose wires or broken pipes.



Figure 15 - Valve Open/Closed

5. Check that the two heater unions are hand tight.

⚠ Caution: Do not use a wrench. Over-tightening may cause damage to unions and gaskets, which will not be covered under warranty.



Figure 16 - Unions Tight

6. Check that the unions on all pumps are tight.
7. Clean out any foreign debris from within the service access area or inside of

the hot tub itself.

8. With the drain open and filters removed, thoroughly rinse out the hot tub with warm water until the drained water runs clear. Run water through the filtration canister and jet lines to remove any incidental dust, dirt, and debris that may have accumulated during shipment or installation. Drain all water completely.
9. Make sure that the hot tub drain valve is closed and the cap is on tight (see page 43).
10. Install the filter(s) in the filtration canister.
11. Check that all of the hot tub jets are open (turned full counter-clockwise).
12. Now is the best time to clean and polish the surfaces of your hot tub if you wish (see page 35).

Filling Your Hot Tub

Now it's time to fill your hot tub with water. Do not turn on the electricity yet until the hot tub is completely filled. To properly fill your hot tub:

1. Unlock and remove Filter Ring.(Figure 17)
2. Remove Filtration Canister.
3. Make sure that the filters (in the filtration canister) are gently screwed into place. Turn them clockwise until they stop being careful not to over-tighten them (this avoids cracking the filter).
4. Connect a standard garden hose to a faucet with regular cold tap water (not softened water or hot water).



Figure 17 – Filtration Canister

- ⚠ Caution:** The water from your hot water tank should not be used to fill the hot tub.
5. Put the pre-filter (if equipped**) on the other end of the hose, point the pre-filter into a suitable drain, turn on the water, and allow any sediment to be flushed down the drain. Once the water stream runs clear, turn off the hose.
 6. Put the pre-filter (if equipped) into the filtration canister and turn on the hose.
 7. **Fill slowly.** If too much water pressure is used, foaming water can force air into the pipes and cause startup problems.

Important: To assure that the pump is properly primed, **fill the hot tub through the filter area only.**

** Pre-filters are available by calling 727.573.9611

8. Fill the hot tub until the water level is about 1" above all jets (or about ½" below the pillow). Do not over fill.

Note: Every person entering a hot tub displaces a given volume of water, so adjust water level to the number of people regularly using the hot tub.

Turn off the hose and check again for any small leaks.

Operational Checks

⚠ Caution: Do not turn on any pump until your hot tub is properly filled with water. Running any pump without water in your hot tub can cause IMMEDIATE damage, which is not covered under warranty!

By now you have rechecked your tub's mechanical connections and filled it with water to about 1" above all jets by adding cold tap water through the pre-filter (if equipped). Turn on power to the hot tub at the main breaker panel and test the operation of the electrical system. If you encounter a problem, please reference the troubleshooting guide on page 38.

1. Turn on the breaker and test the operation of the Ground-Fault Circuit Interrupter (or RCD) breaker by pushing the small button. This should automatically trip the hot tub's circuit breaker.

⚠ DANGER: If this breaker does not trip, immediately call your electrician. Do not use your hot tub!

Only if pushing this button successfully trips this circuit breaker should you reset this breaker and proceed to the next step.

2. Go to the topside control panel. The hot tub first goes into a 6-minute Priming mode, indicated by "Pr" message. Water heating is disabled during priming. To exit Priming mode and begin normal hot tub operation, press "WARM" (or the up arrow) or "COOL" (or the down arrow).
3. Press the "JETS" button. You should hear pump 1 turn on, see water circulating, and see the Jets light illuminate on the panel.
4. Press the JETS button again. You should hear the pump turn on a higher speed.

⚠ Caution: If water is not flowing from the jets after 2 minutes, turn the power off at the main panel and bleed air from the system (see page 30). Turn the power on again. Sometimes momentarily turning the pump off/on will help to prime. Do this only 4 times.

5. If the water is flowing smoothly through the lines, open the air control valve to the jets and you should see an increase in jet pressure. Check and adjust the water and airflow of every jet if necessary.

Each jet in your hot tub can be adjusted for massage intensity and directional flow. Turn the outer jet dial counterclockwise to increase the water volume and clockwise to turn it off. Pivot the angle of a jet to achieve an optimal massage.

An air mixture intensifies the level of your massage. Turn the air control

valve counterclockwise to increase the air mixture and clockwise to turn it off.

To minimize heat loss, close the air control valve when the hot tub is not in use.

6. Press the JETS button a third time to turn off pump 1.

Note: The pump remains on if filtration or heat is needed.

7. Press the LIGHT button to turn on all lights. Verify that the LED light system is on. Press the LIGHT button multiple times to cycle through the many available color patterns. Press the LIGHT button again to turn off the LED light system.
8. If equipped, press the "AUX" button. You should hear pump 2 turn on, see water circulating, and see the AUX light illuminate on the panel.
9. Press the AUX button again to turn off pump 2.

Water Balancing

Note: If your Leisure's Edge hot tub comes with a built-in SPA FROG(optional) sanitizing system. Depending on the area you live in and the local regulatory rules, your SPA FROG consists of some combination of a mineral cartridge and a bromine cartridge manufactured directly in the plumbing line of your hot tub. Here's how it works:

The SPA FROG In-Line System is made up of (A) a FROG cap that is easily distinguishable among the fittings on the top of the spa, (B) a cartridge holder that pulls out of the system, (C) a mineral cartridge that controls bacteria in the water and (D) a bromine cartridge that helps support the minerals while oxidizing contaminants like body oils. The cartridges are adjustable to meet your specific spa water care needs.



A. FROG Cap



C. Mineral Cartridge



D. Bromine Cartridge

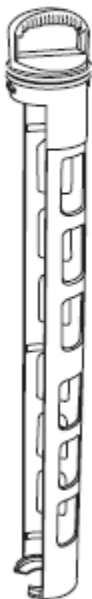

B. Cartridge Holder

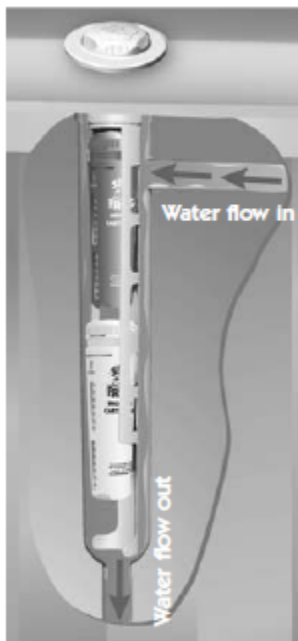

Cut-away view of cartridges snapped into holder and placed into the In-Line System

SPA FROG START UP: After you have filled and balanced the water in your hot tub according to the chart in Table 4, proceed with the SPA FROG as follows:

*NOTE: Bromine levels are lower only when used with FROG minerals. Use a metal out or sequestering agent if fill water is high in metals. Wait 24 hours before continuing start up. Shock hot tub to establish a 1.0-2.0 ppm bromine or chlorine residual. Add directly to hot tub water. Do NOT add through the SPA FROG In-Line System. When spa reaches 95 degrees, set the mineral and bromine cartridges according to the directions below and insert them into the System.

Note: Test strips and water balancing chemicals are available by calling 800.749.8003 or visiting www.hottubparts.com

Test	Range
Total Alkalinity	80-180 ppm
pH	7.2-7.8
Calcium Hardness	150-400 ppm
Bromine	1.0-2.0 ppm

Table 4 - Recommended Ranges for Balanced Water Using Spa Frog

ADJUSTING AND REPLACING SPA FROG BROMINE CARTRIDGE: As every hot tub is different, finding the right setting for the bromine cartridge will require monitoring your usage for the first week or two. Begin with an initial setting of 3 (if you set your filtration cycle to 1 hour a day) or 2 (if you set your filtration cycle to 2 or more hours a day) and monitor bromine levels before each use. Adjust the cartridge by one setting per use until a 1.0-2.0ppm level has been achieved. To adjust cartridge, remove from system and turn to the next higher setting if the bromine level is low, or the next lower setting if the bromine level is high. The bromine cartridge needs to be replaced when empty. Drain water to ensure empty then discard in trash. On most hot tubs, it will last between 2 – 4 weeks. Always maintain at least 1.0 ppm bromine level.

ADJUSTING AND WHEN TO REPLACE SPA FROG MINERAL CARTRIDGE: Set SPA FROG Mineral Cartridge wide open on #6 by holding the bottom and turning the top until the number 6 appears in the setting window. The SPA FROG Mineral Cartridge must be replaced every 4 months. After four months of use, or when draining and refilling the hot tub with fresh water, discard SPA FROG Mineral Cartridge in trash even if, upon shaking, it appears there is spent media left inside. Once wetted, the time-released minerals in the cartridge are effective up to four months. Do not attempt to reuse the product once removed from the hot tub. For ease in remembering, mark your calendar.



NOTE: The more you use your Leisure's Edge hot tub, for instance when you first get it, the greater the setting to achieve at least 1.0 ppm will need to be. If usage decreases or the bromine level is greater than 2.0 ppm, the setting should be lowered.

REPLACING SPA FROG CARTRIDGES: WITH JETS TURNED OFF, open cap of the SPA FROG and set aside. Remove holder by pushing down and turning counterclockwise before pulling out. Remove spent cartridges by pushing bottom out through openings in back of holder. Then grab cartridge and pull out.

NOTE: See page 37 for a photo of the Spa Frog sanitation system installed in a Leisure's Edge spa.

- Snap the SPA FROG Mineral Cartridge into the area marked "Minerals" (top portion) and the SPA FROG Bromine Cartridge into the area marked "Bromine" (bottom portion) making sure to line up the indentation at the top of the cartridges with the raised area on the holder.



***Placement printed on back of holder**

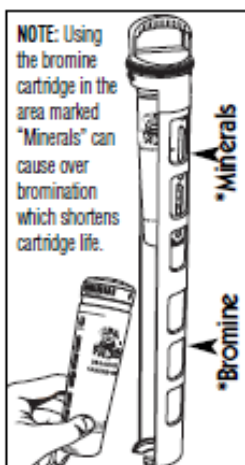

- Slowly insert holder into system. Line up holder arrow-① with system arrow-②. Push down until holder tabs-③ go past system tabs-④ and turn holder to the right (clockwise) until it stops. To ensure a locked position, attempt to pull holder up. If it stays in place, the lock is secure.

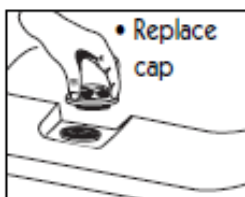
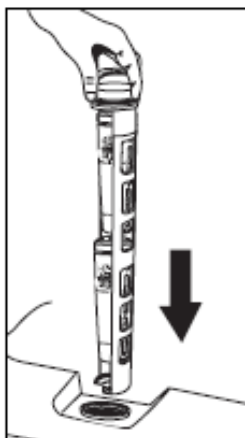
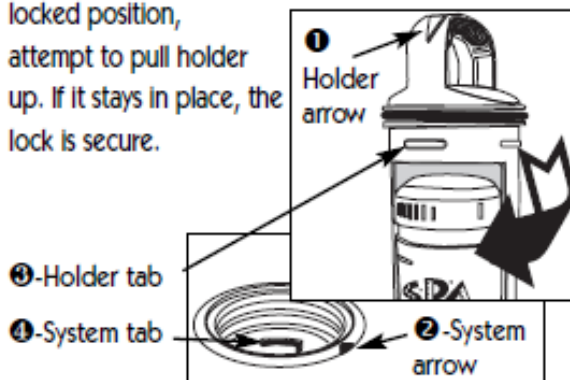

- Begin regular spa care procedures as soon as start-up is complete.

Topside Controls & Operation

LE 852, LE 851, LE 850, LE 744, LE 742 (& LE 630 Export Only) – (VL600S)

The topside control panel operates and programs your hot tub. Basic button functions are described next.

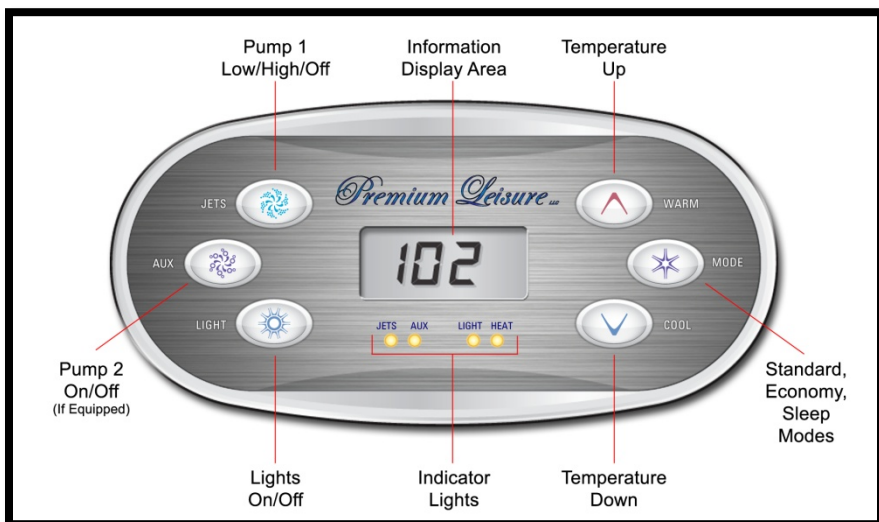

Figure 18 – Topside Callouts for VL600S Controls

LE 630 (U.S. and Canada) – (MVP 260)

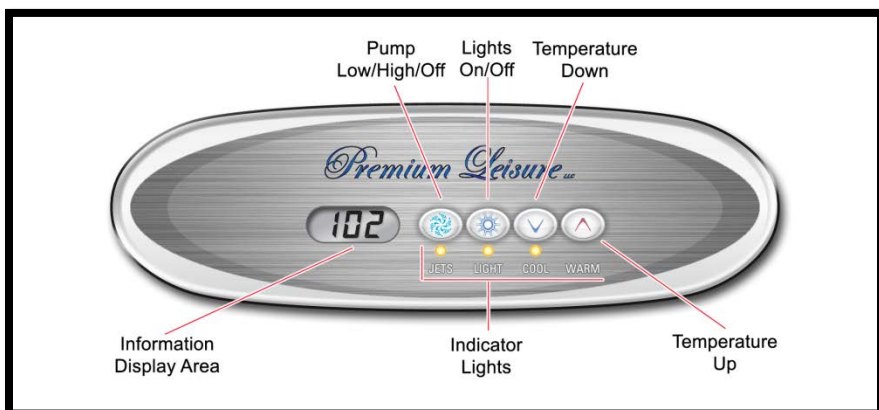

Figure 19 – Topside Callouts for MVP 260 Controls

Initial Start Up

When your hot tub is first actuated, it will go into Priming mode, indicated by “Pr.” The priming mode will last for less than five minutes. Press “WARM” or “COOL” to skip Priming Mode and then the hot tub will begin to heat and maintain the temperature in “Standard Mode.”

Warm/Cool Buttons (Set Temperatures between 80°F - 104°F / 26°C - 40°C)

The startup temperature is set at 100°F/37°C. The last measured temperature is constantly displayed on the LCD and is current only when the pump has been running for at least two minutes. To **display** the set temperature, press the “WARM” or “COOL” button once. To **change** the set temperature, press the “WARM” or “COOL” button a second time before the LCD stops flashing. Each press of the “WARM” or “COOL” button will continue to raise/lower the set temperature. After three seconds, the LCD will stop flashing and display the current hot tub temperature.

Jets Button

Press the “JETS” button once to activate the low speed of Pump 1. Press it a second time to activate the high speed of Pump 1. Press it a third time to turn off Pump 1. If left running, the high speed of Pump 1 automatically will turn off after 15 minutes and the low speed of Pump 1 automatically will turn off after 4 hours.

The low speed of Pump 1 runs when the “AUX” Pump 2 (if equipped) is on. It may also active for at least two minutes every half hour to detect the hot tub temperature and then to heat to the set temperature if needed (depending on mode). When the low speed turns on automatically, it cannot be deactivated from the panel, however the high speed may be activated.

Aux Button (LE 852, LE 851, LE 850, LE 744, LE 742 only)

Press the “AUX” button once to turn on Pump 2 (if equipped). Press it a second time to turn off Pump 2. If left running, Pump 2 automatically will turn off after 15 minutes.

Light

Press the “LIGHT” button once to turn on your hot tub lights. Press the LIGHT button multiple times to cycle through the many available color patterns. Press the LIGHT button again to turn off the LED light system. If left on, the lights automatically turn off after 4 hours.

Mode

Your hot tub operating mode is changed by first pressing the “WARM” or “COLD” button, then pressing the “MODE” button (in the LE 852, LE 851, LE 850, LE 744, LE 742) or the “LIGHT” button (in the LE 630).

- **Standard Mode** is programmed to constantly maintain the desired temperature. “Std” (or “St” in the LE 630) will be displayed momentarily

when you switch into standard mode.

- **Economy Mode** heats the spa to the set temperature *only* during filter cycles. “*Ecn*” (or “*Ec*”) will display solid when temperature is not current and will alternate with temperature when temperature is current.
- **Sleep Mode** heats the hot tub to within 20°F/10°C of the set temperature *only* during filter cycles. “*SLP*” (or “*SL*”) will display solid when temperature is not current and will alternate with temperature when temperature is current.

Preset Filter Cycles

The first filter cycle begins six minutes after the hot tub is energized. The second filter cycle begins 12 hours later. Filter duration is programmable for 2, 4, 6 or 8 hours – or for continuous filtration indicated by “*FILC*” (or “*FC*”). The default filter time is four hours (twice daily).

To program filter cycles, press “WARM” or “COOL” and then “JETS.” Press “WARM” or “COOL” again to adjust to your desired setting. Press “JETS” again to exit filter cycle programming.

The low speed of the 2-speed pump runs during filtration and the ozonator will be enabled.

Smart Winter Mode



If the system (sensor located inside heater) detects ambient conditions below 44°F/6.7°C, it automatically enters the Smart Winter Mode for period of four minutes after it detects the hot tub temperature has risen to 45°F/7.2°C.

Programming Summary

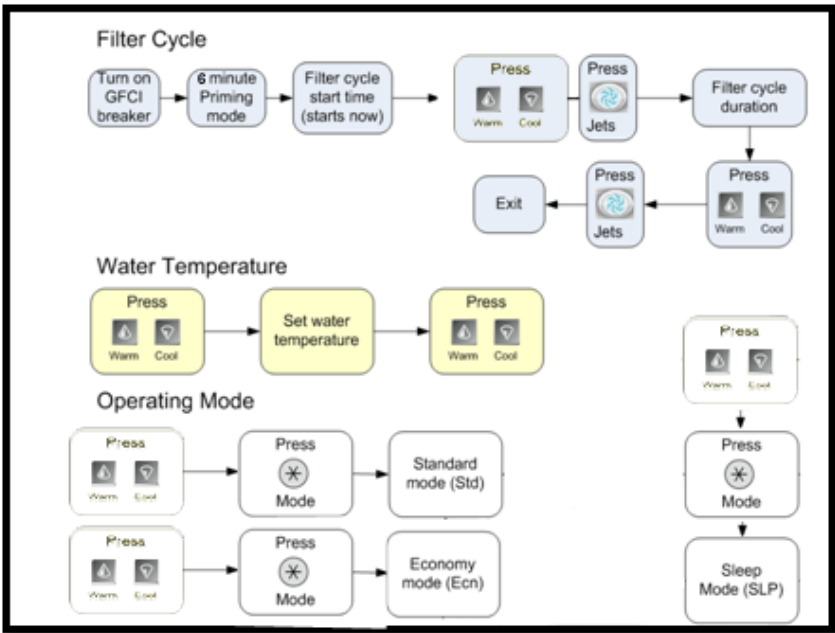

Figure 20 – VL600S Programming Summary

NOTE FOR THE LE 630 MODEL WITH THE MVP 260 TOPSIDE CONTROLS:

- Follow the above steps to set the filter cycle and water temperature.
- To set the operating modes in the LE 630, follow the steps above *except* instead of pressing "Mode" – press "LIGHT."

Stereo System (optional)

Using the Built-in MP3 Docking Station and Speakers

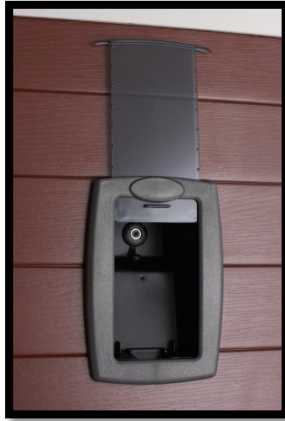

Figure 21 – MP3 Docking Station with Jack

Simply plug in your MP3 player, push play and select your desired volume. Your favorite music is amplified through a built-in subwoofer (underneath your hot tub) and is heard through two built-in speakers (located either near your filter or near your topside controls).

For safety reasons, rest your MP3 player inside the docking station and slide the plastic cover down to protect from water splashing. Do not attempt to handle your MP3 player while bathing in your hot tub.



Figure 22 – Built-in Speakers Above Filter

Cover

Place the insulated cover on your hot tub. Keeping the cover in place anytime the hot tub is not in use reduces the heating time and minimizes operating costs. The time required for initial heat-up varies depending on the starting water temperature, ambient temperature, and the capacity of your hot tub.

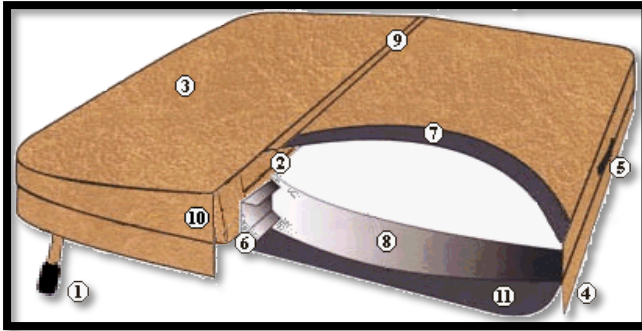

Figure 23 - Cover Callouts

- | | |
|--------------------------------|-------------------------------------|
| 1. Lock-down tab | 7. Heat-sealed insulation |
| 2. Double-stitched seams | 8. Chemical-resistant vapor barrier |
| 3. Marine-grade cover material | 9. Polystyrene seam stoppers |
| 4. Edge overlap material | 10. Reinforced edges |
| 5. Grip handle | 11. Breathable underside material |
| 6. Aluminum channel | |

Use the lock-down tabs to prevent access to the hot tub by children and to prevent the wind from lifting the cover off.



**Figure 24 -
Lockdown Tabs**

Sitting, standing, and snow buildup on the cover will break the cover. Dragging it over rough surfaces will scuff or tear the fabric. Always lift by the handles or use the optional cover lift device.

Frequently Asked Questions

Who do I call for warranty information or service?

Call our customer care center between 8 a.m. and 5 p.m. EST Monday through Friday at 727.573.9611. Our representatives are eager to assist or you can order parts online at www.HotTubParts.com.

How do I bleed air from my system?

When draining and refilling your hot tub, the pump may become air locked. Air-locked pumps stop water from flowing in your hot tub and is easily resolved by bleeding off the trapped air. To do this:

1. Turn off the GFCI (or RCD) breaker
2. Open the access panel below the topside control panel
3. Loosen a heater union until you hear the trapped air escape
4. Once water drips out in a continuous stream, hand tighten the union until the water stops leaking
5. Loosen the discharge union on Pump 2 (if equipped)
6. Once water drips out in a continuous stream, hand tighten the union until the water stops leaking
7. Turn on all pumps to make sure that there are no leaks
8. Put the access panels back on
9. Turn on the GFCI (or RCD) breaker

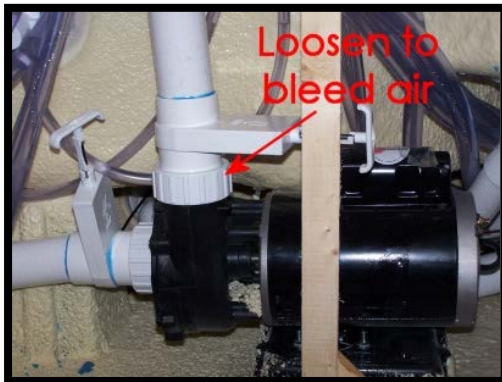

Figure 25 - Bleeding Air

Where can I get more Chemicals or other accessories?

Visit www.HotTubParts.com or call 877.530.PARTS.

What happens when my warranty expires?

Premium Leisure will continue to provide service for your hot tub after your warranty has expired via our customer care center at 727.573.9611.

How should I clean my hot tub?

Use non-sudsing cleaners and non-oily polishes (see page 44). Our Citra Bright Spray Cleaner and our Tub Rub cleaning pad quickly removes scum lines and helps restore your shell's original beauty. Rinse all filters, covers, pillows, and surfaces thoroughly with warm tap water. Our Filter Clean concentrated cleanser is a safe, effective way to clean and re-use your filters and our Jet Clean plumbing cleanser cleans the inside of all plumbing in your hot tub. Call 727.573.9611 to order these easy-to-use cleaning products.

How often should I drain my hot tub?

You should drain and refill your hot tub every 1-3 months depending on usage. Every other time you drain and refill, you should also replace the filters and wipe down the hot tub (see page 43).

Are the jets removable? Interchangeable? Replaceable?

Most jets are made removable and adjustable for customized hydrotherapy. When removing and interchanging, remember to match the same size jets.

What is the insulation made of?

We use a Thermazone™ process to fully insulate all of our hot tubs. First, the bottom of each shell is blanketed with a thick layer of solid-cell, high-density insulating foam. Second, a blanket layer of reflective foil insulation is wrapped around the entire interior of the cabinet. Third, an air-tight, foamed base prevents heat loss. Fourth, a 5-inch thick insulating cover is included.

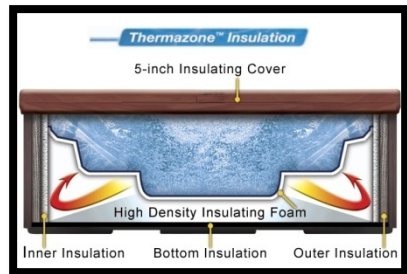

Note: Some spas may be equipped with Therm-Xtreme, which is an additional insulation system designed for cold climates. When this system is installed, your spa will come equipped with ventilation vents on the front or the side of the spa cabinet. To open, slide the vent to the left (for warm or hot temperatures). Or to close (for cold climate conditions), slide the vent to the right.



Vent Open



Vent Closed

How do I adjust my jet?

Simply turn the jets counterclockwise to open and clockwise to close. Be careful not to overturn the jets, as damage can occur.

⚠ Caution: Do not turn off too many jets at the same time. This can create backflow and possible damage to your hot tub!

What is the shell made of?

We use Lucite® Cast Acrylic with Microban® Antimicrobial Protection for most of our hot tub shells.

Microban antimicrobial product protection is built-in to Lucite acrylic during the manufacturing process to help prevent the growth of stain causing bacteria on the surface of the hot tub.

Microban protection works continuously to keep the surface of the hot tub cleaner and won't wash off or wear away for protection that lasts the lifetime of the hot tub.



**Figure 26 – Leisure's Edge Callouts
(Model LE 742)**

Leisure's Edge Hot Tub Models

LEISURE'S EDGE



LE 852 LE 851 LE 850 LE 744 LE 742 LE 630



Photo of the Spa Frog System Loaded in the Inline Plumbing Chamber

Troubleshooting

If a problem arises, you can check this list for a quick solution. If this does not resolve your problem, please call our customer care center at 727.573.9611. Additional information is also available at www.PremiumLeisure.com.

Important – Most problems can be quickly resolved by resetting the GFCI (or RCD) breaker. Try this first before proceeding.

PROBLEM	CAUSE	SOLUTION	
Breaker trips	Wiring error	Load Neutral wire not connected to GFCI (connected to Neutral bus)	
	Wrong GFCI	GFCI breaker is wrong size	
	Ozonator (or blower) wet	Remove tube from ozonator (or blower) and allow 2 days to dry out	
Foamy water	Soaps, skin oils, or undissolved sanitizer particles	Close the air control valves and allow filtration cycle to run Add defoamer Drain and clean your hot tub Clean or change filters Rinse all bathing suits before bathing	
	Leak	Loose connection	Check and hand-tighten unions at heater & pumps, or clamps on jets
		Drain open	Close drain valve or replace cap
	Light doesn't work	LED burnt out	Replace LED
Loose wire		Check wiring harness to LED	
Loose plug		Reseat J20 plug on hot tub pack	
Low/no jet pressure	Air lock	Bleed air from the system (page 34)	
	Dirty filter	Check and clean or replace filter	
	Closed jets	Open all jets by turning CCW	
	Closed valves	Open all T-handle shutoff valves on heater and pumps	
	ACV open	Close air control valves	
Moved my hot tub and now it doesn't work	Low water	Fill hot tub 1" above all jets	
	Wiring error at GFCI	Check Neutral wiring of GFCI (see diagrams on pages 10-20)	
	No power to hot tub	Reset circuit breakers on GFCI panel and main circuit breaker panel	
Nothing works	Breaker has tripped	Check and reset breaker. If problem persists, check for loose electrical connections. Check for Neutral wiring error at GFCI.	
	Fuse blown	Check for blown Fuse (F5) inside of spa pack.	
Pump not running	No power to hot tub	Reset circuit breakers on GFCI panel and main circuit breaker panel	

PROBLEM	CAUSE	SOLUTION
Water does not flow	Air lock	Bleed air from the system (page 34)
	Closed jets	Open all jets by turning counterclockwise
	ACV open	Close air control valves
Water too hot	High set temperature	Turn down set temperature on topside control panel
	High ambient temperature	Remove the cover
Water will not heat	Thermostat is set too low	Check and reset to desired temperature
	Air open	Close air control valve
	Dirty filter	Check and clean filter
	Blown fuse	Check and replace fuse
	Slide valve closed	Check and open all valves
	Cover off	Put the cover back on
	Hot tub in Economy mode	Press the Standby button and take out of Economy (see <i>Economy Mode</i> on page 29)

Error Codes

MESSAGE	MEANING	ACTION REQUIRED
<i>(none)</i>	No message on display. Power has been cut off to hot tub.	The control panel is disabled until power returns. Hot tub settings are preserved.
OHH	The hot tub has shut down from high heat detection. One of the sensors detected 118°F (48°C) at the heater.	Do not enter the water. Remove the cover and allow the water to cool. Once cool, push any button. If the hot tub does not reset, turn off the GFCI and call service.
OHS	The hot tub has overheated and shut down. One of the sensors detected that the hot tub water is 110°F (43°C).	Do not enter the water. Remove the cover and allow the water to cool. At 107°F (42°C), the hot tub resets automatically. If the hot tub does not reset, turn off the GFCI and call service.
ICE	Potential freeze condition detected (Ice)	No action required. The pump will automatically operate regardless of the hot tub status.

MESSAGE	MEANING	ACTION REQUIRED
SnA	Sensor A is not working correctly. Hot tub is shut down.	Check the sensor "A" plug connection to circuit board. The problem may appear temporarily in an overheat situation and disappear when the heater cools. If the problem persists, contact service.
Snb	Sensor B is not working correctly. Hot tub is shut down.	Check the sensor "B" plug connection to circuit board. The problem may appear temporarily in an overheat situation and disappear when the heater cools. If the problem persists, contact service.
SnS	Sensors are out of balance.	If this alternates with the temperature, it may be temporary. If the display shows only this message (periodically blinking), the hot tub is shut down .If the problem persists, contact service.
HFL	A substantial difference between sensors was detected (possible flow problem).	Check water level in hot tub and add water if necessary. Be sure that slide-valves are open. Make sure the pump is primed and has power. If the problem persists, contact service.
LF	<i>Low Flow</i> – persistent problem. Displays after the fifth occurrence of the "HFL" message within 24 hours. Heater shuts down but other hot tub functions run normally.	Follow action for "HFL" message. Heating ability of the hot tub will not reset automatically; press any button to reset.
dr	Inadequate water, poor flow, or air bubbles detected in the heater. Hot tub is shut down for 15 minutes.	Check the water level and add water if necessary. Be sure that slide-valves are open. Make sure the pump is primed and has power. Press any button to reset (automatically reset within 15 minutes). If the problem persists, contact service.
drY	Inadequate water detected in heater. Displays on third occurrence of "dr" message. Hot tub is shut down.	Check water level in hot tub. Add water if necessary. Be sure that slide-valves are open. Make sure the pump is primed and has power. Press any button to reset.
Pr	When the hot tub is first activated, it goes into Priming mode.	The Priming mode runs for up to four minutes and then the hot tub begins to heat and maintain the water temperature in Standard mode.

Hot Tub Parts

(877)-530-PARTS



Hot Tub Storage Steps
Chemical friendly storage.
Pt # 7851 (Brown)
Pt # 7852 (Grey)



Hot Tub Cover Lifter
Installs in minutes!
Pt # 7315



Hot Tub Safety Handrail
Installs in minutes!
Pt # 7240



Hot tub Crystal Fragrance
Aromatherapy Experience
Pt # 7684 (Apple Essence)



Hot Tub Equipment Control System
Hydro-Quip/Easy Install!
Pt # CS-500C



Hot Tub Hammock
Backyard vacation...
Pt # 7770



Hot Tub Mineral Disc
Chlorine Free Maintenance for up to 60 days.
Natural Copper/Zinc Media
Pt # 832297



Hot Tub Filter 50 SqFt
Platinum/Sterling Leisure Tubs
Pt # 6136

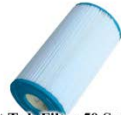

Hot Tub Filter 50 SqFt
Waterway Filter System
Pt # 3033

6101 45th Street N, Saint Petersburg, FL 33714

Toll Free: 877-530-PARTS

FAX: 727-522-5838

WWW.HOTTUBPARTS.COM

Maintenance & Care

Important – The warranty on your hot tub and equipment depends on proper sanitation (see pages 22). In addition, the following maintenance procedures must be followed periodically.

Cabinets

Your cabinet is made from a polymer that combines the durability of plastic with the beauty of simulated wood. To clean the cabinet, a mild soap and water solution easily removes residue.

Cover

The 5-inch thick tapered cover on your hot tub is made from a weatherproof marine-grade vinyl. Your cover will last much longer if you heed the following suggestions:

- 1) Don't drag the cover on the ground; wearing of the vinyl could easily develop into a tear.
- 2) The insulating foam in your cover is not designed to hold the weight of a person or an animal.

Important – Cracked foam in the cover is not covered under warranty! Do not stand on it.

- 3) Occasionally clean the cover with our special Cover Wipes. Call our order line at 727.573.9611 to order our Cover Wipes.
- 4) Our special Vinyl Cover Cleaner applied to the outside of the cover and stitching once yearly will keep your cover looking better longer. Call our order line at 727.573.9611 to order our special Vinyl Cover Cleaner.
- 5) Do not lift the cover by the safety straps, they are made to secure the tub to the cabinet and may tear.

Draining and Refilling

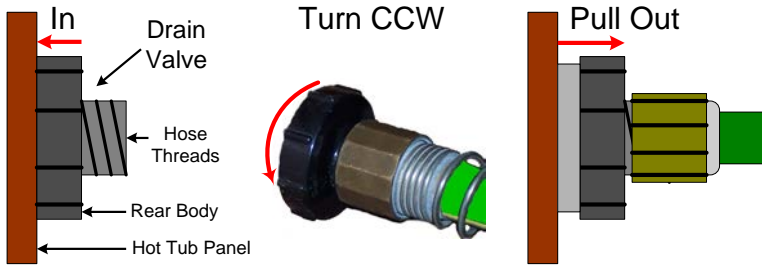

Figure 27 - Drain Operation

- 1) Turn off the GFCI (or RCD) breaker.
- 2) Remove hot tub cover and allow water to cool down.
- 3) Select a safe, suitable drainage area capable of safely assimilating 300 plus gallons of water that may contain unsanitary contaminants and chemical residue that could cause harm to plants or grass.
- 4) Locate drain valve at front of the hot tub (see page 36). Hold the rear body to prevent it from turning, then loosen and remove the front cap.
- 5) Attach a garden hose to the exposed threads and route the hose downhill to your drainage area.
- 6) Twist the drain fitting 1/3 turn counterclockwise to unlock the drain valve and pull it outward to open completely. The water will drain by gravitational flow.
- 7) After the hot tub drains, perform steps 3-5 in reverse order to close the drain prior to refilling hot tub.
- 8) Attach the garden hose to a thoroughly-flushed pre-filter (not included, rinsed of all residual sediment) and refill your hot tub through the filtration canister.
- 9) After refilling, turn on the GFCI (or RCD) breaker to the hot tub.

If the pump runs but no water flows, see page 34 to see how to bleed air from the system.

Filters

The filters in your hot tub should be removed and cleaned every 2 weeks with our special Filter Clean concentrated cleanser and typically replaced every 4-6 months (depending upon use). You can clean your filters with the water pressure from the end of a garden hose then rinse with warm water. This ensures that the water is being filtered properly.

DO NOT USE BLEACH. We recommend having replacement filters on hand that can be swapped between cleanings. Doing so enables you to quickly exchange the dirty filters with clean ones and immediately start your hot tub again. Call our order line at 727.573.9611 to order replacement filters and our special Filter Clean concentrated cleanser.

Jets

Remove and clean the jets as needed using our special our Jet Clean plumbing cleanser, water, and a cloth or soft-bristled brush. Call our order line at 727.573.9611 to order our special our Jet Clean plumbing cleanser.

Light

Drain the hot tub and clean the light lens as needed using an optical cloth and an eyewear cleaning product specifically designed not to scratch optical surfaces. If the back side of the lens is also dirty, remove the rear panel, remove the light from the holder, and clean in this same manner.

Pillows

Remove and clean the headrest pillows as needed using our Citra Bright Spray Cleaner and our Tub Rub cleaning pad and rinse thoroughly with warm water. Call our order line at 727.573.9611 to order our Citra Bright Spray Cleaner and our Tub Rub cleaning pad.

Sanitation

Sanitation level is influenced by two factors:

1. Filter Cycle (filtration) time (see page 30)
2. How much you use your hot tub each week

If your water chemistry and water clarity are all proper and your sanitation level is still too low/high, you can adjust the sanitation intensity up/down by adjusting the bromine level on your Spa Frog or adding more/less sanitizer directly to the water a little at a time and testing the water again after two days.

Shutdown / Winterizing



Your Leisure's Edge hot tub is designed to operate year round. If you plan to leave your hot tub unused for long periods of time in severely cold weather, you should winterize your hot tub to avoid accidental freezing due to a power or equipment failure.

We highly recommend that you have a hot tub professional winterize and restart your hot tub.

⚠ WARNING: Damage from improperly winterizing or restarting your hot tub is not covered under your warranty. You can call our customer care center, at 727.573.9611 for recommended service organizations to assist you in properly winterizing your hot tub.

Surface

The acrylic surface of your hot tub should be cleaned with our Citra Bright Spray Cleaner and our Tub Rub cleaning pad and thoroughly rinsed with warm (not cold) water before refilling. Call our order line at 727.573.9611 to order cleaners.

⚠ WARNING: NEVER use paint solvents, acids, acetone, benzene, lacquer thinner, toluene, xylene, or similar chemicals to clean the shell.

Water Management

Our chemical water purification system is a perfect match for your hot tub.

Depending on usage, the water in your hot tub should be changed every 1-3 months. Upon each change of water it is a good practice to wipe down the hot tub.

If your water quality seems improper, increasing the time the hot tub filters the water (see page 30) may clear up your problem.

Below are some answers to common water chemistry questions.

pH	It is common to have pH fluctuations after adding chemicals to your hot tub or after a party. Let your jets run and give your water time to stabilize. Nine times out of 10, your pH will come back into the 7.2-7.8 range on its own.
MILDEW on cover	Mildew usually grows in the folds and seams of your cover and then drips into your hot tub water causing cloudiness and/or odor. Clean with our special Citra Bright Spray Cleaner and then rinse the inside of your cover with clean warm water.
Foamy water	Foam typically results from soap residue on your skin and hair, or laundry detergent residue on clothing. Take a soapless shower and rinse all clothing in warm water prior to bathing.
CLEAR green or brown water	Your "source water" most likely has dissolved heavy metals. When this is the case, order our special Metal Gon metal remover. Using a pre-filter can remove these contaminants before they get into your hot tub (see page 22).
CLOUDY green water	Algae can be resolved by adding our hot tub algacide.
CLOUDY white water	Although a normal condition immediately after filling that dissipates after time, with stabilized water this is a visual indication that the total alkalinity or pH or both are at improper levels. Test your water weekly and maintain proper water chemistry.
ODOR and/or CLOUDY water	If your water develops an odor and/or cloudiness, clean your cover and filters and try increasing the amount of time the hot tub filters per day by turning your filtration cycle time or duration up.
HEAVY use	After a period of heavy use, your hot tub may cloud. Shock your hot tub with 2 ounces of non chlorine shock and wait 36 hours.

Specifications

LE 850 (Model 1404)

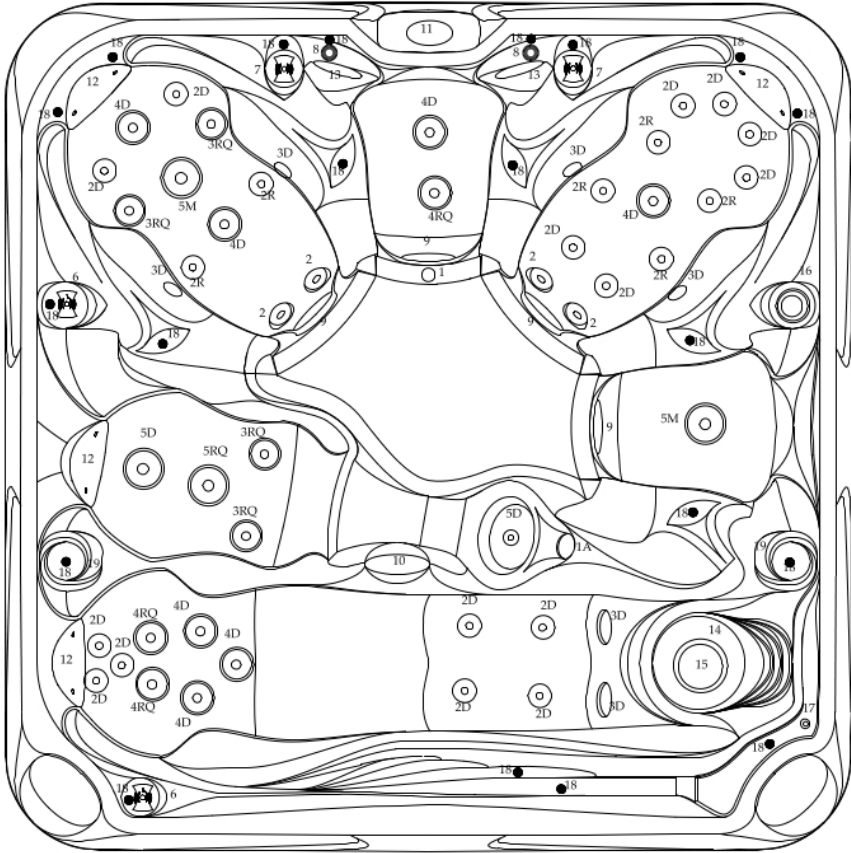

Specifications*

Spa Spec	
Spa Model	LE850(1404LE)
Spa Dimension	91"x91"x36"
Number Of Seats	6 (2 Lounges)
Water Jets	50
Air Jets	0
Water Capacity (USG/L)	378/1431
Dry Weight (LBS/KG)	900/408
Filled Weight (LBS/KG)	4054/1839
Electrical Rating (VAC/AMP/HZ)	240/50/60
GFCI (AMP)	60

* Specifications are subject to change without notice.

Call-Outs				
Label	Part#	Description	Qty.	Notes
1, 1A	073199W, 7818, 7379	Nozzle wall fitting, Floor drain/Wall fitting	1+1+1	
2	212-9879PSEDSG, 211-0320G	Ozone jet(ss/gr), Straight body	4	
2D	29527-011-500, 29222-200-300 23422-000-010	2.25" PrLc Jet Int(Leaf, Dir. (SS/Sil/IGG/GG); 200s Jet body, 3/4SB x 3/8"SB, Compensator Ring.	15	
2R	29527-021-500, 29222-200-300, 23422-000-010,	2.25" PrLc Jet Int(Leaf, Roto (SS/Sil/IGG/GG); 200s Jet body, 3/4SB x 3/8"SB, Compensator Ring.	6	
3D	29537-111-500, 29232-200-200, 23432-000-010	3.25" PrLc Jet Int(Leaf, Dir. (SS/Sil/IGG/GG); 300s Jet body, 3/4SB x 3/8"SB, Compensator Ring.	6	
3RQ	29537-101-500, 29232-200-200, 23432-000-010	3.25" PrLc Jet Int(Leaf, 4-Roto (SS/Sil/IGG/GG); 300s Jet body, 3/4SB x 3/8"SB, Compensator Ring.	4	
3R	29537-121-500, 29232-200-200, 23432-000-010	3.25" PrLc Jet Int(Leaf, Roto (SS/Sil/IGG/GG); 300s Jet body, 3/4SB x 3/8"SB, Compensator Ring.	0	
4D	29547-111-500, 29242-200-200, 23442-000-010	4.25" PrLc Jet Int(Leaf, Dir. (SS/Sil/IGG/GG); 400s Jet body, 3/4SB x 3/8"SB, Compensator Ring.	7	
4RQ	29547-101-500, 29242-200-200, 23442-000-010	4.25" PrLc Jet Int(Leaf, 4-Roto (SS/Sil/IGG/GG); 400s Jet body, 3/4SB x 3/8"SB, Compensator Ring.	3	
4R	29547-121-500, 29242-200-200, 23442-000-010	4.25" PrLc Jet Int(Leaf, Roto (SS/Sil/IGG/GG); 400s Jet body, 3/4SB x 3/8"SB, Compensator Ring.	0	
5D	29557-011-500, 29252-200-200, 23452-000-010	5.25" PrLc Jet Int(Leaf, Dir. (SS/Sil/IGG/GG); 500s Jet body, 3/4SB x 3/8"SB, Compensator Ring.	2	
5RQ	29557-001-500, 29252-200-200, 23452-000-010	5.25" PrLc Jet Int(Leaf, 4-Roto (SS/Sil/IGG/GG); 500s Jet body, 3/4SB x 3/8"SB, Compensator Ring.	1	
5R	29557-021-500, 29252-200-200, 23452-000-010	5.25" PrLc Jet Int(Leaf, Roto (SS/Sil/IGG/GG); 500s Jet body, 3/4SB x 3/8"SB, Compensator Ring.	0	
5M	29557-041-500, 29252-200-200, 23452-000-010	5.25" PrLc Jet Int(Leaf, Mass. (SS/Sil/IGG/GG); 500s Jet body, 3/4SB x 3/8"SB, Compensator Ring.	2	
6	25059-300-000, 25090-089-200	1" Variable Air Control, Leaf, Sil/IGG/Sil with LED bezel	2	
7	25056-310-000, 25030-089-200	1" On-Off Control, Leaf, Sil/IGG/Sil with LED bezel	2	
8	25269-001-500	2.25" LED Laminar Jet, Leaf	2	
9	640-3789GADSGV	Suction VGB250GPM, (Gr)	4	
10	25242-000-000(1219)	Light Kit 5".	1	
11	50015-05, 13301	TP600CE Panel, PL Overlay	1	
12	823690	Pillow tri-curve	4	
13	531707	Speaker oval, 2.5" (Graphite)	2	
14	510-4609DSG	Teleweir skim filter(Gr)	1	
15	817-4050	50 sq. ft. Cartridge Filter	1	Service part
16	1251, 1252, 01-14-3879	Spa Frog in-line Assy, cap, cartridges	1	
17	670-2009-DSG, 219-5910	Water nozzle w all fitting Assy., check-valve retainer	1+2	
18	1310A, 1315, 1312A, 1317, 3126, 3129, 3130, 25243-600- 000	LED controller, 7-LED Light, 6-LED SPYDER, CABLE ASSY, 1" lens, nut, o-ring, oval Spa Light	1/1/7/1 /19/4	
19	25241-507-800	LED Deco Cup Holder Assy.	2	
N/A	7136, 6022, 310-0140	2 Speed Motor; 4' Cord ; Wet end 310-0140;	1	
N/A	7135, 6024, 310-0140	1 Speed Motor; 4' 8' Cord ; Wet end 310-0140;	1	
N/A	56713	Balboa Pack BP501X	1	
N/A	5071, 7399	Ozonator w/ Cord, Injector	1	
N/A	7652, 7876A	Owner's Manual, insert	1	Leisure Edge
N/A	7986	Spa Cover (91-1/2"x91-1/2"xR10)	1	
N/A	5953, 5954, 5956	Subwoofer 150wt w. harness, power supply 100-240vac, i-pod docking station	1	

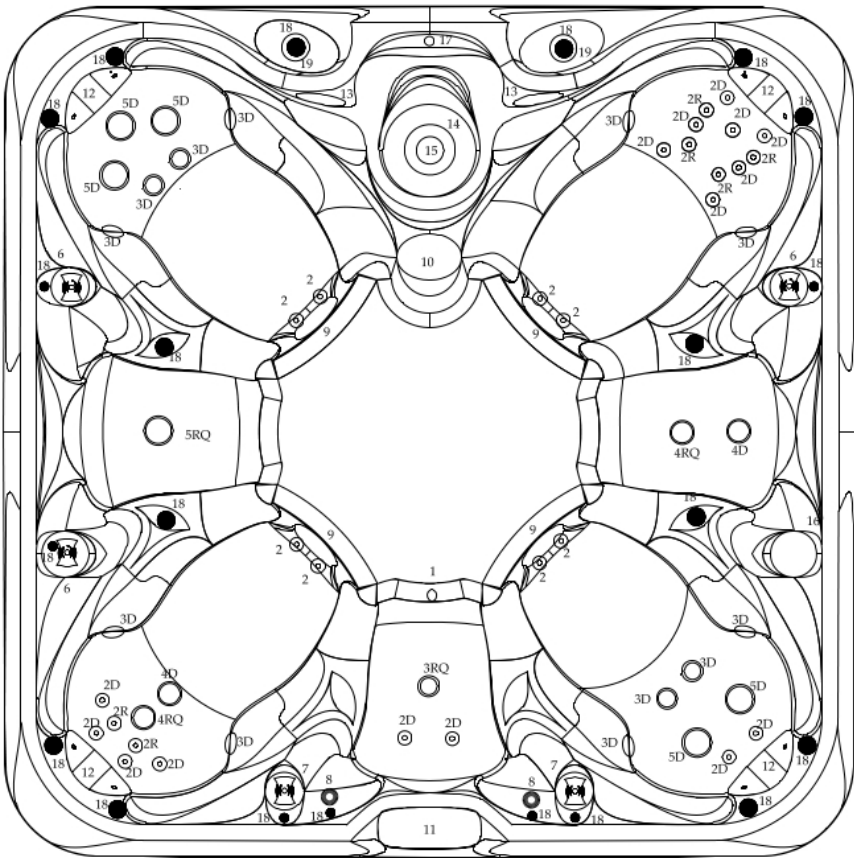

Specifications*

Spa Spec	
Spa Model	LE852 (1405LE)
Spa Dimension	91"x91"x36"
Number Of Seats	7
Water Jets	52
Air Jets	0
Water Capacity (USG/L)	405/1533
Dry Weight (LBS/KG)	900/408
Filled Weight (LBS/KG)	4279/1941
Electrical Rating (VAC/AMP/HZ)	240/50/60
GFCI (AMP)	60

* Specifications are subject to change without notice.

		Call-Outs		
Label	Part#	Description	Qty.	Notes
1, 1A	073199W,7818, 7379	Nozzle wall fitting, Floor drain/Wall fitting	1+1+1	
2	212-9879PSEDSG, 211-0320G	Ozone jet(ss/gr), Straight body	8	
2D	29527-011-500, 29222-200-300 23422-000-010	2.25" PrLc Jet Int(Leaf, Dir. (SS/Sil/IGG/GG); 200s Jet body, 3/4SB x 3/8"SB, Compensator Ring.	15	
2R	29527-021-500, 29222-200-300, 23422-000-010.	2.25" PrLc Jet Int(Leaf, Roto (SS/Sil/IGG/GG); 200s Jet body, 3/4SB x 3/8"SB, Compensator Ring.	6	
3D	29537-111-500, 29232-200-200, 23432-000-010	3.25" PrLc Jet Int(Leaf, Dir. (SS/Sil/IGG/GG); 300s Jet body, 3/4SB x 3/8"SB, Compensator Ring.	12	
3RQ	29537-101-500, 29232-200-200, 23432-000-010	3.25" PrLc Jet Int(Leaf, 4-Roto (SS/Sil/IGG/GG); 300s Jet body, 3/4SB x 3/8"SB, Compensator Ring.	1	
3R	29537-121-500, 29232-200-200, 23432-000-010	3.25" PrLc Jet Int(Leaf, Roto (SS/Sil/IGG/GG); 300s Jet body, 3/4SB x 3/8"SB, Compensator Ring.	0	
4D	29547-111-500, 29242-200-200, 23442-000-010	4.25" PrLc Jet Int(Leaf, Dir. (SS/Sil/IGG/GG); 400s Jet body, 3/4SB x 3/8"SB, Compensator Ring.	2	
4RQ	29547-101-500, 29242-200-200, 23442-000-010	4.25" PrLc Jet Int(Leaf, 4-Roto (SS/Sil/IGG/GG); 400s Jet body, 3/4SB x 3/8"SB, Compensator Ring.	2	
4R	29547-121-500, 29242-200-200, 23442-000-010	4.25" PrLc Jet Int(Leaf, Roto (SS/Sil/IGG/GG); 400s Jet body, 3/4SB x 3/8"SB, Compensator Ring.	0	
5D	29557-011-500, 29252-200-200, 23452-000-010	5.25" PrLc Jet Int(Leaf, Dir. (SS/Sil/IGG/GG); 500s Jet body, 3/4SB x 3/8"SB, Compensator Ring.	5	
5RQ	29557-001-500, 29252-200-200, 23452-000-010	5.25" PrLc Jet Int(Leaf, 4-Roto (SS/Sil/IGG/GG); 500s Jet body, 3/4SB x 3/8"SB, Compensator Ring.	1	
5R	29557-021-500, 29252-200-200, 23452-000-010	5.25" PrLc Jet Int(Leaf, Roto (SS/Sil/IGG/GG); 500s Jet body, 3/4SB x 3/8"SB, Compensator Ring.	0	
5M	29557-041-500, 29252-200-200, 23452-000-010	5.25" PrLc Jet Int(Leaf, Mass. (SS/Sil/IGG/GG); 500s Jet body, 3/4SB x 3/8"SB, Compensator Ring.	0	
6	25059-300-000, 25090-089-200	1" Variable Air Control, Leaf, Sil/IGG/Sil with LED bezel	3	
7	25056-310-000, 25030-089-200	1" On-Off Control, Leaf, Sil/IGG/Sil with LED bezel	2	
8	25269-001-500	2.25" LED Laminar Jet, Leaf	2	
9	640-3789GADSGV	Suction VGB250GPM, (Gr)	4	
10	25242-000-000(1219)	Light Kit 5",	1	
11	50015-005, 13301	Topside panel TP600CE, PL overlay	1	
12	823690	Pillow tri-curve	4	
13	531707	Speaker oval, 2.5" (Graphite)	2	
14	510-4609DSG	Teleweir skim filter(Gr)	1	
15	817-4050	50 sq. ft. Cartridge Filter	1	Service part
16	1251, 1252, 01-14-3879	Spa Frog in-line Assy, cap, cartridges	1	
17	670-2009-DSG, 219-5910	Water nozzle w all fitting Assy., check-valve retainer	1+2	
18	1310A, 1315, 1312A, 1317, 400372-N, 25243-600-000	LED controller, 7-LED Light, 6-LED SPYDER, CABLE ASSY, 1/2" lens, nut, o-ring, oval Spa	1/1/3/1 6/4	
19	25241-507-800	LED Deco Cup Holder Assy.	2	
N/A	7136, 6022, 310-1740SD	2 Speed Motor; 4' Cord ; Wet end 310-1740SD;	1	
N/A	7135, 6024, 310-0140	1 Speed Motor; 4' 8" Cord ; Wet end 310-0140;	1	
N/A	56713	Balboa Pack BP501	1	
N/A	5071, 7399	Ozonator w/ Cord, Injector	1	
N/A	7652, 7876A	Owner's Manual, insert	1	Leisure Edge
N/A	7986	Spa Cover (91-1/2"x 91-1/2"x R10)	1	
N/A	5953, 5954, 5956	Subwoofer 150wt w. harness, power supply 100-240vac, i-pod docking station	1	

LE 742 (Model 1406)

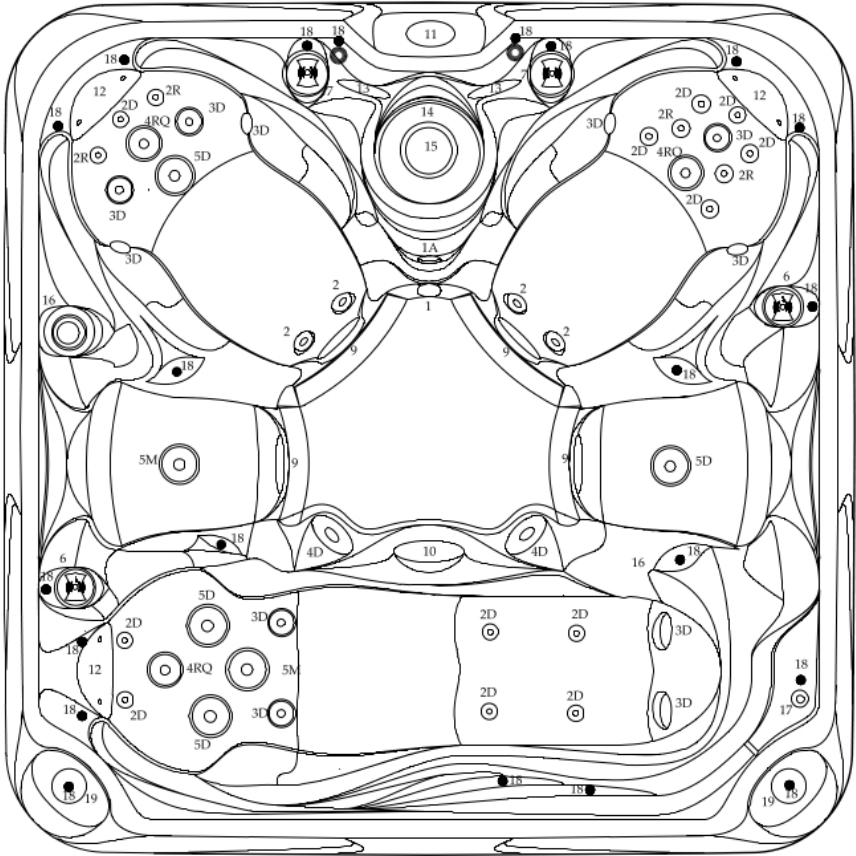

Specifications*

Spa Spec	
Spa Model	LE742(1406LE)
Spa Dimension	84"x84"x36"
Number Of Seats	5(1Lounge)
Water Jets	42
Air Jets	0
Water Capacity (USG/L)	320/1211
Dry Weight (LBS/KG)	840/380
Filled Weight (LBS/KG)	3508/1591
Electrical Rating (VAC/AMP/HZ)	240/50/60
GFCI (AMP)	60

* Specifications are subject to change without notice.

Call-Outs				
Label	Part#	Description	Qty.	Notes
1, 1A	073199W, 7818, 7379	Nozzle wall fitting, Floor drain/Wall fitting	1+1+1	
2	212-9879PSE-5G, 211-0320G	Ozone jet(ss/gr), Straight body	4	
2D	29527-011-500, 29222-200-300 23422-000-010	2.25" PrLc Jet Int(Leaf, Dir. (SS/Sil/IGG/GG); 200s Jet body, 3/4SB x 3/8"SB, Compensator Ring,	12	
2R	29527-021-500, 29222-200-300, 23422-000-010	2.25" PrLc Jet Int(Leaf, Roto (SS/Sil/IGG/GG); 200s Jet body, 3/4SB x 3/8"SB, Compensator Ring,	4	
3D	29537-111-500, 29232-200-200, 23432-000-010	3.25" PrLc Jet Int(Leaf, Dir. (SS/Sil/IGG/GG); 300s Jet body, 3/4SB x 3/8"SB, Compensator Ring,	11	
3RQ	29537-101-500, 29232-200-200, 23432-000-010	3.25" PrLc Jet Int(Leaf, 4-Roto (SS/Sil/IGG/GG); 300s Jet body, 3/4SB x 3/8"SB, Compensator Ring,	0	
3R	29537-121-500, 29232-200-200, 23432-000-010	3.25" PrLc Jet Int(Leaf, Roto (SS/Sil/IGG/GG); 300s Jet body, 3/4SB x 3/8"SB, Compensator Ring,	0	
4D	29547-111-500, 29242-200-200, 23442-000-010	4.25" PrLc Jet Int(Leaf, Dir. (SS/Sil/IGG/GG); 400s Jet body, 3/4SB x 3/8"SB, Compensator Ring,	2	
4RQ	29547-101-500, 29242-200-200, 23442-000-010	4.25" PrLc Jet Int(Leaf, 4-Roto (SS/Sil/IGG/GG); 400s Jet body, 3/4SB x 3/8"SB, Compensator Ring,	3	
4R	29547-121-500, 29242-200-200, 23442-000-010	4.25" PrLc Jet Int(Leaf, Roto (SS/Sil/IGG/GG); 400s Jet body, 3/4SB x 3/8"SB, Compensator Ring,	0	
5D	29557-011-500, 29252-200-200, 23452-000-010	5.25" PrLc Jet Int(Leaf, Dir. (SS/Sil/IGG/GG); 500s Jet body, 3/4SB x 3/8"SB, Compensator Ring,	4	
5RQ	29557-001-500, 29252-200-200, 23452-000-010	5.25" PrLc Jet Int(Leaf, 4-Roto (SS/Sil/IGG/GG); 500s Jet body, 3/4SB x 3/8"SB, Compensator Ring,	0	
5R	29557-021-500, 29252-200-200, 23452-000-010	5.25" PrLc Jet Int(Leaf, Roto (SS/Sil/IGG/GG); 500s Jet body, 3/4SB x 3/8"SB, Compensator Ring,	0	
5M	29557-041-500, 29252-200-200, 23452-000-010	5.25" PrLc Jet Int(Leaf, Mass. (SS/Sil/IGG/GG); 500s Jet body, 3/4SB x 3/8"SB, Compensator Ring,	2	
6	25059-300-000, 25090-089-200	1" Variable Air Control, Leaf, Sil/IGG/Sil with LED bezel	2	
7	25056-310-000, 25030-089-200	1" On-Off Control, Leaf, Sil/IGG/Sil with LED bezel	2	
8	25269-001-500	2.25" LED Laminar Jet, Leaf	2	
9	640-3789GADSGV	Suction VGB 250GPM, (Gr)	4	
10	25242-000-000(1219)	Light Kit 5"	1	
11	50015-005, 13301	Topside panel TP600CE, PL overlay	1	
12	823690	Pillow tri-curve	3	
13	531707	Speaker oval, 2.5" (Graphite)	2	
14	510-4609DSG	Teleweir skim filter(Gr)	1	
15	817-4050	50 sq. ft. Cartridge Filter	1	Service part
16	1251, 1252,01-14-3879	Spa Frog in-line Assy, cap, cartridges	1	
17	670-2009-DSG, 219-5910	Water nozzle w all fitting Assy., check-valve retainer	1+2	
18	1310A, 1315, 1312A, 1318A, 1317, 400372-N, 25243-600- 000	LED controller, 7-LED Light, 6-LED SPYDER, 2- LED SPYDER, CABLE ASSY, 1/2" LENSES W. NUTS, Oval Spa Light	1/1/6/0 /1/1/17/4	
19	25241-507-800	LED Deco Cup Holder	2	
N/A	7136, 6022, 310-1740SD	2 Speed Motor; 6' Cord ; Wet end 310-1740SD;	1	
N/A	7135, 6024, 310-1740SD	1 Speed Motor; 8' Cord ; Wet end 310-1740SD;	1	
N/A	56713	Balboa Pack BP501	1	
N/A	5071, 7399	Ozonator w/ Cord, Injector	1	
N/A	7652, 7876A	Owner's Manual, insert	1	Leisure Edge
N/A	7988	Spa Cover (84-1/2"x84-1/2"xR10)	1	
N/A	5953, 5954, 5956	Subwoofer 150wtw, harness, power supply 100-240vac, i-pod docking station	1	

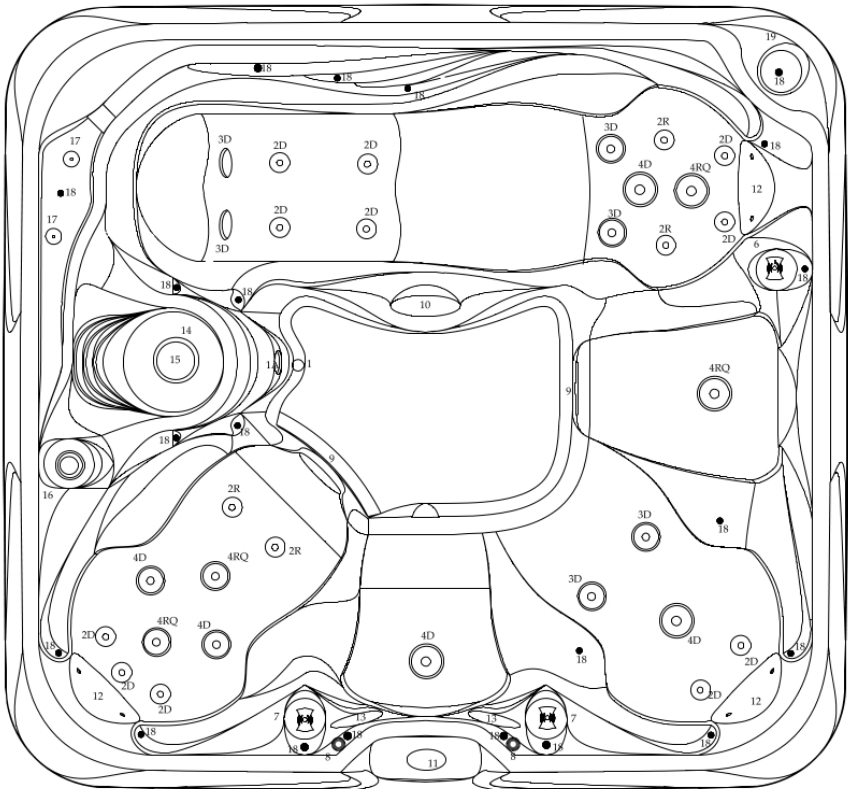

Specifications*

Spa Spec	
Spa Model	LE630(1407LE)
Spa Dimension	84"x78"x34"
Number Of Seats	5 (1 Lounge)
Water Jets	30
Air Jets	0
Water Capacity (USG/L)	290/1098
Dry Weight (LBS/KG)	710/322
Filled Weight (LBS/KG)	3131/1420
Electrical Rating (VAC/AMP/HZ)	240/40/60
GFCI (AMP)	50

* Specifications are subject to change without notice.

		Call-Outs		
Label	Part#	Description	Qty.	Notes
1,1A	073199W, 7818, 7379	Nozzle wall fitting, Floor drain/Wall fitting	1+1+1	
2	212-9879PSEDSDG, 211-0320G	Ozone jet(ss/gr), Straight body	0	
2D	29527-011-500, 29222-200-300 23422-000-010	2.25" PrLc Jet Int(Leaf, Dir. (SS/Sil/IGG/GG); 200s Jet body, 3/4SB x 3/8"SB, Compensator Ring,	11	
2R	29527-021-500, 29222-200-300, 23422-000-010,	2.25" PrLc Jet Int(Leaf, Roto (SS/Sil/IGG/GG); 200s Jet body, 3/4SB x 3/8"SB, Compensator Ring,	4	
3D	29537-111-500, 29232-200-200, 23432-000-010	3.25" PrLc Jet Int(Leaf, Dir. (SS/Sil/IGG/GG); 300s Jet body, 3/4SB x 3/8"SB, Compensator Ring,	6	
3RQ	29537-101-500, 29232-200-200, 23432-000-010	3.25" PrLc Jet Int(Leaf, 4-Roto (SS/Sil/IGG/GG); 300s Jet body, 3/4SB x 3/8"SB, Compensator Ring,	0	
3R	29537-121-500, 29232-200-200, 23432-000-010	3.25" PrLc Jet Int(Leaf, Roto (SS/Sil/IGG/GG); 300s Jet body, 3/4SB x 3/8"SB, Compensator Ring,	0	
4D	29547-111-500, 29242-200-200, 23442-000-010	4.25" PrLc Jet Int(Leaf, Dir. (SS/Sil/IGG/GG); 400s Jet body, 3/4SB x 3/8"SB, Compensator Ring,	5	
4RQ	29547-101-500, 29242-200-200, 23442-000-010	4.25" PrLc Jet Int(Leaf, 4-Roto (SS/Sil/IGG/GG); 400s Jet body, 3/4SB x 3/8"SB, Compensator Ring,	4	
4R	29547-121-500, 29242-200-200, 23442-000-010	4.25" PrLc Jet Int(Leaf, Roto (SS/Sil/IGG/GG); 400s Jet body, 3/4SB x 3/8"SB, Compensator Ring,	0	
5D	29557-011-500, 29252-200-200, 23452-000-010	5.25" PrLc Jet Int(Leaf, Dir. (SS/Sil/IGG/GG); 500s Jet body, 3/4SB x 3/8"SB, Compensator Ring,	0	
5RQ	29557-001-500, 29252-200-200, 23452-000-010	5.25" PrLc Jet Int(Leaf, 4-Roto (SS/Sil/IGG/GG); 500s Jet body, 3/4SB x 3/8"SB, Compensator Ring,	0	
5R	29557-021-500, 29252-200-200, 23452-000-010	5.25" PrLc Jet Int(Leaf, Roto (SS/Sil/IGG/GG); 500s Jet body, 3/4SB x 3/8"SB, Compensator Ring,	0	
5M	29557-041-500, 29252-200-200, 23452-000-010	5.25" PrLc Jet Int(Leaf, Mass (SS/Sil/IGG/GG); 500s Jet body, 3/4SB x 3/8"SB, Compensator Ring,	0	
6	25059-300-000, 25090-089-200	1" Variable Air Control, Leaf, Sil/IGG/Sil with LED bezel	1	
7	25056-310-000, 25030-089-200	1" On-Off Control, Leaf, Sil/IGG/Sil with LED bezel	2	
8	25269-001-500	2.25" LED Laminar Jet, Leaf	2	
9	640-3789GADSGV	Suction VGB 250GPM, (Gr)	2	
10	25242-000-000(1219)	Light Kit 5"	1	
11	50015-005, 13301	Topside panel TP600CE, PL overlay	1	
12	823690	Pillow tri-curve	3	
13	531707	Speaker oval, 2.5" (Graphite)	2	
14	510-4609DSG	Teleweir skim filter(Gr)	1	
15	817-4050	50 sq. ft. Cartridge Filter	1	Service part
16	1251, 1252,01-14-3879	Spa Frog in-line Assy, cap, cartridges	1	
17	670-2009-DSG, 219-5910	Water nozzle wall fitting Assy., check-valve retainer	2+2	
18	1310A, 1315, 1312A, 1318A, 1317, 400372-N, 25243-600- 000,	LED controller, 7-LED Light, 6-LED SPYDER, 2- LED SPYDER, CABLE ASSY, 1/2" LENSES W. NUTS, Oval Spa light	1/1/3/ 1/1/5/ 4	
19	25241-507-800	LED Deco Cup Holder	1	
N/A	7136, 6022, 310-1740SD	2 Speed Motor; 6" Cord ; Wet end 310-1740SD;	1	
N/A	7135, 6024, 310-1740SD	1 Speed Motor; 8" Cord ; Wet end 310-1740SD;	0	
N/A	56713	Balboa Pack BP501	1	
N/A	5071, 7399	Ozonator w/ Cord, Injector	1	
N/A	7652, 7876A	Owner's Manual, insert	1	Leisure Edge
N/A	7924	Spa Cover (84-1/2"x78-1/2"xR10)	1	
N/A	5953, 5954, 5956	Subwoofer 150wt w. harness, power supply 100-240vac, i-pod docking station	1	

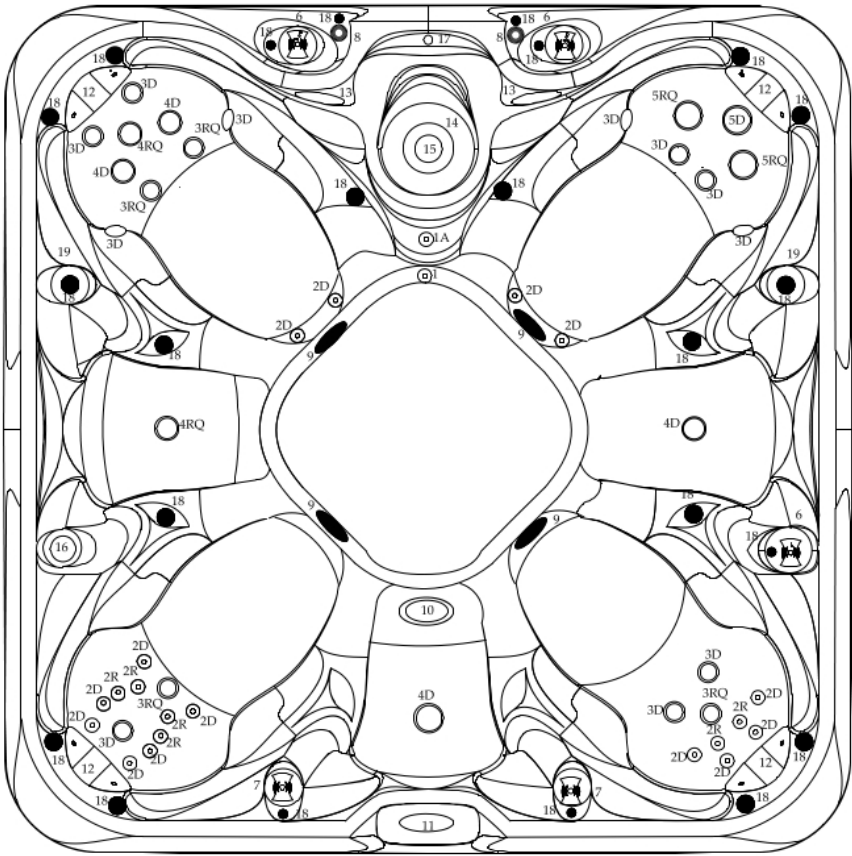

Specifications*

Spa Spec	
Spa Model	LE744 (1408LE)
Spa Dimension	84"x84"x36"
Number Of Seats	7
Water Jets	44
Air Jets	0
Water Capacity (USG/L)	333/1261
Dry Weight (LBS/KG)	840/380
Filled Weight (LBS/KG)	3618/1641
Electrical Rating (VAC/AMP/HZ)	240/50/60
GFCI (AMP)	60

* Specifications are subject to change without notice.

		Call-Outs		
Label	Part#	Description	Qty.	Notes
1,1A	073199W, 7818, 7379	Nozzle wall fitting, Floor drain/Wall fitting	1+1+1	
2	212-9879PSEDSG, 211-0320G	Ozone jet(ss/gr), Straight body		
2D	29527-011-500, 29222-200-300 23422-000-010	2.25" PrLc Jet Int(Leaf, Dir. (SS/Sil/IGG/GG); 200s Jet body, 3/4SB x 3/8"SB, Compensator Ring,	14	
2R	29527-021-500, 29222-200-300, 23422-000-010,	2.25" PrLc Jet Int(Leaf, Roto (SS/Sil/IGG/GG); 200s Jet body, 3/4SB x 3/8"SB, Compensator Ring,	6	
3D	29537-111-500, 29232-200-200, 23432-000-010	3.25" PrLc Jet Int(Leaf, Dir. (SS/Sil/IGG/GG); 300s Jet body, 3/4SB x 3/8"SB, Compensator Ring,	15	
3RQ	29537-101-500, 29232-200-200, 23432-000-010	3.25" PrLc Jet Int(Leaf, 4-Roto (SS/Sil/IGG/GG); 300s Jet body, 3/4SB x 3/8"SB, Compensator Ring,	0	
3R	29537-121-500, 29232-200-200, 23432-000-010	3.25" PrLc Jet Int(Leaf, Roto (SS/Sil/IGG/GG); 300s Jet body, 3/4SB x 3/8"SB, Compensator Ring,		
4D	29547-111-500, 29242-200-200, 23442-000-010	4.25" PrLc Jet Int(Leaf, Dir. (SS/Sil/IGG/GG); 400s Jet body, 3/4SB x 3/8"SB, Compensator Ring,	4	
4RQ	29547-101-500, 29242-200-200, 23442-000-010	4.25" PrLc Jet Int(Leaf, 4-Roto (SS/Sil/IGG/GG); 400s Jet body, 3/4SB x 3/8"SB, Compensator Ring,	2	
4R	29547-121-500, 29242-200-200, 23442-000-010	4.25" PrLc Jet Int(Leaf, Roto (SS/Sil/IGG/GG); 400s Jet body, 3/4SB x 3/8"SB, Compensator Ring,		
5D	29557-011-500, 29252-200-200, 23452-000-010	5.25" PrLc Jet Int(Leaf, Dir. (SS/Sil/IGG/GG); 500s Jet body, 3/4SB x 3/8"SB, Compensator Ring,	3	
5RQ	29557-001-500, 29252-200-200, 23452-000-010	5.25" PrLc Jet Int(Leaf, 4-Roto (SS/Sil/IGG/GG); 500s Jet body, 3/4SB x 3/8"SB, Compensator Ring,	0	
5R	29557-021-500, 29252-200-200, 23452-000-010	5.25" PrLc Jet Int(Leaf, Roto (SS/Sil/IGG/GG); 500s Jet body, 3/4SB x 3/8"SB, Compensator Ring,	0	
5M	29557-041-500, 29252-200-200, 23452-000-010	5.25" PrLc Jet Int(Leaf, Mass. (SS/Sil/IGG/GG); 500s Jet body, 3/4SB x 3/8"SB, Compensator Ring,	0	
6	25059-300-000, 25090-089-200	1" Variable Air Control, Leaf, Sil/IGG/Sil with LED bezel	3	
7	25056-310-000, 25030-089-200	1" On-Off Control, Leaf, Sil/IGG/Sil with LED bezel	2	
8	25269-001-500	2.25" LED Laminar Jet, Leaf	2	
9	640-3789GADSGV	Suction VGB250GPM, (Gr)	4	
10	25242-000-000(1219)	Light Kit 5",	1	
11	50015-005, 13301	Topside panel TP600CE, PL overlay	1	
12	823690	Pillow tri-curve	4	
13	531707	Speaker oval, 2.5" (Graphite)	2	
14	510-4609DSG	Teleweir skim filter(Gr)	1	
15	817-4050	50 sq. ft. Cartridge Filter	1	Service part
16	1251, 1252, 01-14-3879	Spa Frog in-line Assy, cap, cartridges	1	
17	670-2009-DSG, 219-5910	Water nozzle w al fitting Assy., check-valve retainer	1+2	
18	1310A, 1315, 1312A, 1317, 400372-N, 25243-600-000	LED controller, 7-LED Light, 6-LED SPYDER, CABLE ASSY, 1/2" lens, nut, o-ring , oval Spa Light	1/16/0/1/1 8/4	
19	25241-507-800	LED Deco Cup Holder Assy.	2	
N/A	7136, 6022, 310-1740SD	2 Speed Motor; 6' Cord ; Wet end 310-1740SD;	1	
N/A	7135, 6024, 310-0140	1 Speed Motor; 8' Cord ; Wet end 310-0140;	1	
N/A	56713	Balboa Pack BP501	1	
N/A	5071, 7399	Ozonator w/ Cord, Injector	1	
N/A	7652, 7876A	Owner's Manual, insert	1	Leisure Edge
N/A	7988	Spa Cover (84-1/2"x 84-1/2"x R10)	1	
N/A	5953, 5954, 5956	Subwoofer 150wt w. harness, power supply 100-240vac, i-pod docking station	1	

LE 855 (Model 1409)

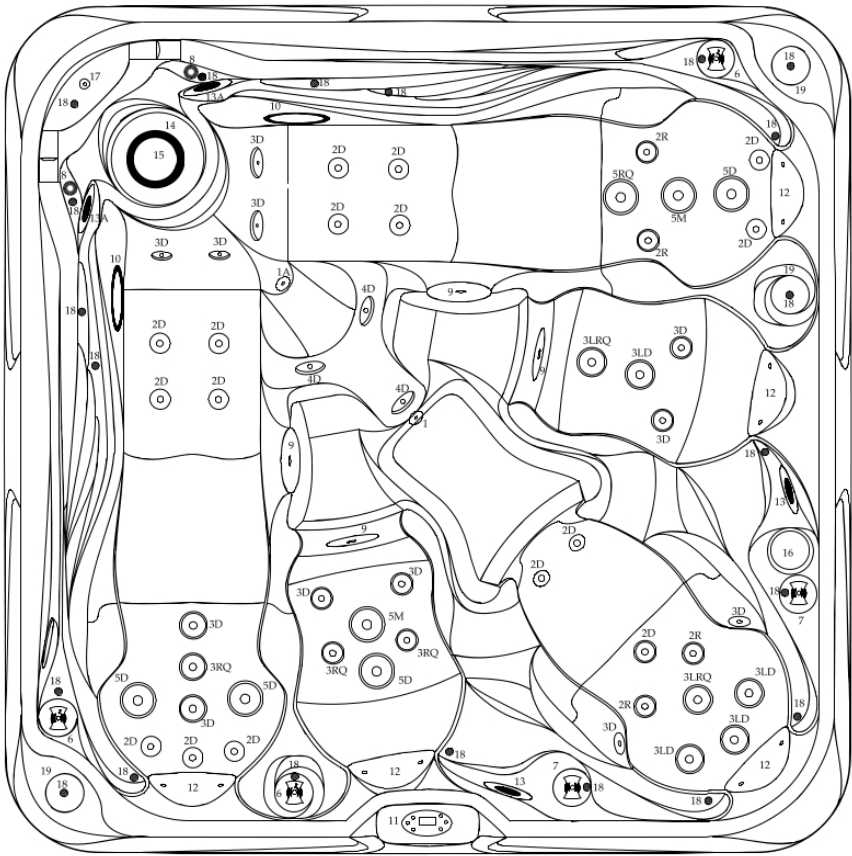

Specifications*

Spa Spec	
Spa Model	LE851(1409LE)
Spa Dimension	91"x91"x36"
Number Of Seats	5 (2 L)
Water Jets	51
Air Jets	0
Water Capacity (USG/L)	378/1431
Dry Weight (LBS/KG)	900/408
Filled Weight (LBS/KG)	4054/1839
Electrical Rating (VAC/AMP/HZ)	240/50/60
GFCI (AMP)	60

* Specifications are subject to change without notice.

		Call-Outs		
Label	Part#	Description	Qty.	Notes
1,1A	073199W, 7818, 7379	Nozzle wall fitting, Floor drain/Wall fitting	1+1+1	
2	212-9879PSEDSG, 211-0320G	Ozone jet(ss/gr), Straight body	0	
2D	29527-011-500, 29222-200-300 23422-000-010	2.25" PrLc Jet Int(Leaf, Dir. (SS/Sil/IGG/GG); 200s Jet body, 3/4SB x 3/8"SB, Compensator Ring	16	
2R	29527-021-500, 29222-200-300, 23422-000-010,	2.25" PrLc Jet Int(Leaf, Roto (SS/Sil/IGG/GG); 200s Jet body, 3/4SB x 3/8"SB, Compensator Ring	4	
3D	29537-111-500, 29232-200-200, 23432-000-010	3.25" PrLc Jet Int(Leaf, Dir. (SS/Sil/IGG/GG); 300s Jet body, 3/4SB x 3/8"SB, Compensator Ring,	12	
3RQ	29537-101-500, 29232-200-200, 23432-000-010	3.25" PrLc Jet Int(Leaf, 4-Roto (SS/Sil/IGG/GG); 300s Jet body, 3/4SB x 3/8"SB, Compensator Ring,	3	
3R	29537-121-500, 29232-200-200, 23432-000-010	3.25" PrLc Jet Int(Leaf, Roto (SS/Sil/IGG/GG); 300s Jet body, 3/4SB x 3/8"SB, Compensator Ring	0	
3LD	29537-011-500, 29232-200-200, 23432-000-010	3.6" PrLc Jet Int(Leaf, Dir. (SS/Sil/IGG/GG); 300s Jet body, 3/4SB x 3/8"SB, Compensator Ring	4	Large face
3LRQ	29537-001-500, 29232-200-200, 23432-000-010	3.6" PrLc Jet Int(Leaf, 4-Roto (SS/Sil/IGG/GG); 300s Jet body, 3/4SB x 3/8"SB, Compensator Ring	2	Large face
4D	29547-111-500, 29242-200-200, 23442-000-010	4.25" PrLc Jet Int(Leaf, Dir. (SS/Sil/IGG/GG); 400s Jet body, 3/4SB x 3/8"SB, Compensator Ring,	3	
5D	29547-111-500, 29252-200-200, 23452-000-010	5.25" PrLc Jet Int(Leaf, Dir. (SS/Sil/IGG/GG); 500s Jet body, 3/4SB x 3/8"SB, Compensator Ring,	4	
5RQ	29557-001-500, 29252-200-200, 23452-000-010	5.25" PrLc Jet Int(Leaf, 4-Roto (SS/Sil/IGG/GG); 500s Jet body, 3/4SB x 3/8"SB, Compensator Ring	1	
5R	29557-021-500, 29252-200-200, 23452-000-010	5.25" PrLc Jet Int(Leaf, Roto (SS/Sil/IGG/GG); 500s Jet body, 3/4SB x 3/8"SB, Compensator Ring	0	
5M	29557-041-500, 29252-200-200, 23452-000-010	5.25" PrLc Jet Int(Leaf, Mass. (SS/Sil/IGG/GG); 500s Jet body, 3/4SB x 3/8"SB, Compensator Ring,	2	
6	25058-300-000, 25090-089-200	1" Variable Air Control, Leaf, Sil/IGG/Sil with LED bezel	3	
7	25058-310-000, 25030-089-200	1" On-Off Control, Leaf, Sil/IGG/Sil with LED bezel	2	
8	25269-001-500	2.25" LED Laminar Jet, Leaf	2	
9	640-3789GADSGV	Suction VGB250GPM, (Gr)	4	
10	25242-000-000(1219)	Light Kit 5',	2	
11	50015-005, 13301	Topside panel TP600CE, PL overlay	1	
12	823690	Pillow tri-curve	5	
13	531707	Speaker oval, 2.5" (Graphite)	2	
14	510-4609DSG	Teleweir skim filter(Gr)	1	
15	817-4050	50 sq. ft. Cartridge Filter	1	Service part
16	1251, 1252, 01-14-3879	Spa Frog in-line Assy, cap, cartridges	1	
17	670-2009-DSG, 219-5910	Water nozzle wall fitting Assy., check-valve retainer	1+2	
18	1310A, 1315, 1312A, 1317, 400372-N, 25243-600-000	LED controller, 7-LED Light, 6-LED SPYDER, CABLE ASSY, 1/2" lens, nut, o-ring, oval Spa Light	1/1/3/0/1/1/ 6/4	
19	25241-507-800	LED Deco Cup Holder Assy,	3	
N/A	7138, 6022, 310-0140	2 Speed Motor; 6' Cord ; Wet end 310-0140;	1	
N/A	7135, 6024, 310-0140	1 Speed Motor; 8' Cord ; Wet end 310-0140;	1	
N/A	56713	Balboa Pack BP501	1	
N/A	5071, 7399	Ozonator w/ Cord, injector	1	
N/A	7652, 7876A	Owner's Manual, insert	1	Leisure Edge
N/A	7986	Spa Cover (91-1/2"x91-1/2"xR10)	1	
N/A	5953, 5954, 6956	Subwoofer 150wt.w. harness, power supply 100-240vac, i-pod docking station	1	

LIMITED WARRANTY

Premium Leisure, LLC ("Premium Leisure") provides a limited Warranty for the Leisure Edge Spa (the "Spa") in accordance with the time periods and other terms and conditions described below (the "Warranty"). If you have any questions regarding Warranty issues, please contact us.

Structural and Manifold Plumbing Parts (Lifetime): Premium Leisure warrants the Spa's shell structure against the loss of water through the fiberglass laminate of the shell caused by defects in materials and workmanship. Premium Leisure also warrants that the plumbing manifold system (i.e. manifold, fittings and related parts) will be free from defects in materials and workmanship. The Warranty for these components covers only parts and extends for as long as the original purchaser owns the Spa. In the event the Spa is not owned by the original purchaser, the Warranty for these components is limited to two (2) years from the original purchaser's date of purchase.

Spa Surface (Five (5) years, pro rated): Premium Leisure warrants the Spa's interior acrylic spa surface against blisters, cracks, or delaminating resulting from a defect in materials or workmanship of the acrylic surface material for a period of five (5) years from the original date of purchase. The Warranty for the acrylic spa surface covers both parts and labor, and is pro rated based on the following formula: Suggested retail price divided by months covered (60), multiplied by months owned plus shipping = replacement cost.

Major Spa Components (Two (2) years): Premium Leisure warrants the Spa's major electrical equipment (electrical system, Spa controls and motors) to be free of defects in materials and workmanship for a period of two (2) years from the original purchaser's date of purchase. The Warranty on these components covers only parts, such replacement parts to be obtained directly from Premium Leisure, and defective parts returned to Premium Leisure. All labor necessary for installation of the Spa's major electrical equipment must be approved in advance by Premium Leisure, and is not covered under this Warranty.

Cabinet (One (1) year): Premium Leisure warrants the Spa's simulated wood cabinet, including the materials, structural integrity and assembly of the cabinet, will be free of defects in materials and workmanship for a period of one (1) year from the original purchaser's date of purchase. The cosmetic finish of the Spa's wood cabinet is warranted to be free from defect in materials and workmanship at time of initial delivery. Fading and weathering of the cabinet surface may occur naturally over time and shall not be considered a defect. To restore the appearance of the Spa's wood cabinet, please refer to the Spa's owner's manual for proper care and maintenance instructions.

Other Spa Components and Optional Accessory Items: All components of the Spa not described above are covered by a 90 day, parts only, Warranty. These components include, but are not limited to, the Spa's optional accessory items such as optional fixtures, trim kits, skirts, CD & MP3 players and other music and video devices, ozone, waterfall assembly, and lighting systems. All perishable, cosmetic or owner serviceable items, spa cover, light bulb, light lenses, fuses, headrests, filters, cover-lift, spa drain, jet inserts, etc. are warranted to be free of defects in materials and workmanship at the time of the Spa's delivery. Certain items described in this paragraph may be covered by a separate manufacturer's Warranty. Premium Leisure may serve as an agent in presenting claims under these manufacturers' warranties, but will not be responsible if such Warranty claims are limited or denied. In the event Premium Leisure provides parts to replace an alleged defective part covered by an independent manufacturer's Warranty, the Spa owner will be responsible for the item's cost and applicable shipping charges, and will be credited with item cost upon the manufacturer accepting the Warranty claim and providing Premium Leisure with a replacement item.

Warranty Performance: In the event of a suspected defect covered by the terms of this Warranty,

the Spa owner must notify us within a reasonable time and use all reasonable means to protect the Spa from further damage. A service representative will provide the technical labor only, to affect the repair subject to the terms and conditions contained in this Warranty. The service representative may assess reasonable travel charges. Visits to simply diagnose, troubleshoot, or inspect problems are not covered under this Warranty. If we determine that repairs are not feasible due to functional defect, we reserve the right to provide a replacement part or spa in lieu of repair. We will replace with a part of value equal to the original purchase. In such event, owner is responsible for expenses including removal, shipping, and re-installation of the existing or replacement Spa. The replacement Spa or part will carry the balance of the original Spa's Warranty, if any.

Limitations and Exclusions

This Warranty applies to spas sold after July 1, 2012, and takes effect from the date the Spa was originally purchased or six months from the date of manufacture whichever comes first. This Warranty applies only to the original purchaser and terminates with any transfer of ownership. This Warranty does not apply to a Spa used for any commercial, rental, club purposes, or for any Spa used outside of the United States. All Warranty claims must be accompanied by a sales invoice showing date of purchase. This Warranty does not cover damage resulting from moving the Spa, abuse, misuse, or neglect, including but not limited to any installation, operation, maintenance or use of the Spa other than in accordance with the Spa's Owner's Manual. Also excluded from this Warranty is coverage for damage caused by (a) operation of the Spa at water temperatures outside the range of 32 and 104 degrees Farenheight, (b) dirty, clogged, or calcified filter cartridges, (c) improper use of chemicals or cleaning agents, (d) allowing un-dissolved spa sanitizing chemicals to lie on the surface, (e) improper pH balance or other improper water chemistry, (f) failure to provide even and sufficient structural support for the Spa, (g) repairs or alterations performed by anyone other than a Premium Leisure authorized service representative, and (h) acts of God (including lightning strikes), nonstructural normal wear and tear, cosmetic blemishes and other causes beyond Premium Leisure's control.

WARRANTY Disclaimers

The Warranty is in lieu of all other warranties, expressed or implied, including implied warranties of merchantability and fitness for a particular purpose. In no event shall Premium Leisure be liable for incidental or consequential damages. The Spa owner is required to provide unencumbered access to the Spa for any Warranty repair or inspection. Premium Leisure shall not be liable for loss of use of Spa or other incidental or consequential costs, expenses or damages, which may include, but are not limited to water damage, or the removal of a permanent deck or other customer fixture. Under no circumstances shall Premium Leisure, or any of its representatives, be held liable for injury to any person or damage to any property, however arising. This Warranty gives you specific legal rights and you may have other rights. Premium Leisure's waiver or failure to enforce any of the terms or conditions of the Warranty shall not in any way affect, limit or waive its right at any time to enforce strict compliance with every term and condition thereof. No service company or other party is authorized to change, modify, or extend the terms of this Warranty in any manner whatsoever. The jurisdiction and venue for any litigation arising with respect to the transaction evidenced by this Warranty shall be the Circuit Court in and for Pinellas County, Florida, and any party submitting a claim under this Warranty hereby agrees to such jurisdiction and venue.

Notes

LEISURE'S EDGE

6101 45th St. N.
St. Petersburg, FL 33714
727.573.9611

www.PremiumLeisure.com