



For decades, the Founders of Alfresco have been manufacturing commercial kitchen equipment for many of the Nation's finest restaurants and hotels. Alfresco Open-Air Culinary Systems was launched, offering a whole new level of quality in luxury residential appliances. This would be the most complete line of restaurant-inspired luxury outdoor kitchen appliances, utilizing the same manufacturing methodologies used in commercial restaurant equipment.

Alfresco appliances will make any professional chef feel right at home, and will inspire anyone who wishes to produce culinary creations like a pro. Unparalleled quality, workmanship, performance, and design combined with constant innovation have been the driving force in making Alfresco the most distinctive and complete line of outdoor kitchen appliances available today. All Alfresco appliances are proudly built from scratch in Commerce, California - U.S.A.

*Create the Alfresco outdoor kitchen
of your dreams, and luxuriate in the lifestyle.*

GRILL FEATURES



ALFRESCO'S EXCLUSIVE HEAT DELIVERY SYSTEM

Delivers evenly distributed extreme high-heat to the cooking surface, and consists of special 18SR burners

- o 27,500 BTUs
- o 18SR (Scaling and Corrosion Resistant) made from titanium and stainless steel
- o Exclusive design: Dual rows of clean-combusting, double-lanced ports on three sides, plus crossover tube in front delivering optimal flame distribution
- o Lifetime warranty



SEAR ZONE™

- o Exclusive 1500° Infrared Technology
- o 27,500 BTU Infrared Burner available on all LXE grills with 100% combusting ceramic surface for intense even heat and authentic steakhouse results
- o Reaches 1500° F in four minutes and cooks 50% faster with virtually no flare-ups
- o Special “V-shaped” flavorizer cooking grate over Sear Zone™ burner captures the natural juices, fats, and flavors, then caramelizes them to the food for delectable mouthwatering flavor



MADE IN THE U.S.A.

Made from all commercial-grade 304, 18-8 stainless steel, all heli-arc hand-welded seams with no mechanical fasteners.



REFRACTIVE CERAMIC 5-WAY HEAT DISTRIBUTING BRIQUETTES

Eliminate hot and cold spots making the effective grilling area 100% of the grilling surface. A special pyramid shape with a flat top and heat-holding cavity on underside evenly delivers intense heat to the cooking surface. Radiant tray locks briquettes in place. Turn tray over and fire burners on high with lid closed to self-clean.

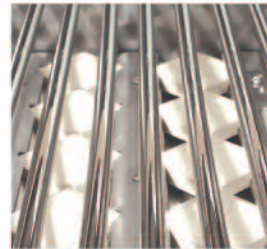

STAINLESS STEEL COOKING GRATES

Over briquette and “U” burner sections. Heavy-duty 3/8-inch round stainless steel rod cooking grates have a special nonstick electro-polished finish.



ADJUSTABLE FOOD WARMING AND GRILLING RACK

The three-position adjustable warming rack stores up and out of the way when rotissing. Ideal for above-grilling-surface holding and cooking.



PRECISION CONTROL PANEL LIGHTING

All new LED front panel lighting projects rich amber beams of light exactly where you need them.



NEWLY REDESIGNED CONTROLS
Stainless steel push-button ignition, lighting, and rotisserie controls are ergonomically integrated into the front control panel.



ATTRACTIVE NICKEL-PLATED ERGONOMICALLY-DESIGNED CONTROL KNOBS AND BEZELS
The all-new grill knobs have been redesigned with precision touch in mind.



HALOGEN WORK LIGHTS
Integrated high-intensity halogen work lights angle slightly toward the center for bright, even illumination. Light lens is easily removable without the use of tools for easily changing bulbs, and cleaning.



 **EXCLUSIVE HEAT PROTECTED WIRING**
Electrical wires are each encapsulated their full length with a 600° heat-resistance silicone sleeve, and all electric connectors are protected with a silicone boot of same heat resistance silicone.



 **EXCLUSIVE CONTROL PANEL AIR COOLING CURTAIN**
A special air-cooling plenum blasts a curtain of cool air that naturally flows up between the front control panel and firebox keeping front panel and bullnose safely cool to the touch. This also protects all the electronics.



FLUSH INSET ROTISSERIE BURNER
All Alfresco grills come with a flush-mounted 1500° rear ceramic infrared rotisserie burner.



 **INTEGRATED, WOOD SMOKER AND HERB INFUSION SYSTEM**
Dedicated 5,000 BTU stainless steel burner. Exclusive cold smoke capabilities. Drawer holds large chunks of wood, and linear defusing vents naturally eject smoke at 200° to food zone.



 **EXCLUSIVE HIDDEN AND INTEGRATED 120 LB. TORQUE MEGA ROTISSERIE MOTOR**
This unique chain-driven whisper quiet system turns food at a smooth and consistent speed no matter how many pounds. No counter balance required. Produces hassle-free delicious rotisssed foods. Smoketiss™ using the smoke and herb infusion system.



FIT AND FINISH
With hand-polished accents, uniquely clean lines, and all heli-arc welded seams, the beauty and quality are in the details.

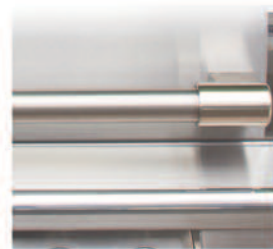

 **EXCLUSIVE HOOD-ASSIST SYSTEM**
Unique integrated and hidden spiral torsion system made of non-corrosive stainless steel for many years of use. Handle spins smoothly in nickle-plated end caps for optimal comfort.

56" LXE ALL GRILL

- o Three 18-SR stainless steel main burners producing 82,500 BTUs
- o Sear Zone™ with 27,500 BTU ceramic infrared burner
- o Integrated rotisserie system with built-in motor and dual 15,000 BTU infrared burners
- o Smoker system with 5,000 BTU dedicated burner and drawer for wood chunks
- o 998 sq. in. actual grilling area
- o 3-position warming racks stores up and out of the way when rotissing
- o Dual integrated high-intensity halogen work lights
- o User-friendly push-button ignition with sealed 110v AC power source
- o Cart model features dual storage drawers
- o Optional refrigerated base cabinet

AVAILABLE MODELS

| | |
|-------------|--------------------------------|
| ALXE-56BFG | 56" Jumbo Built-in Grill |
| ALXE-56BFGC | 56" Jumbo Cart Model Grill |
| ALXE-56BFGR | 56" Jumbo on Refrigerated Cart |

Available in LP or Natural Gas



Built-in Model



Cart Model



Refrigerated Cart Model

56" LXE DELUXE GRILL

- o Three 18-SR stainless steel main burners producing 82,500 BTUs
- o Integrated rotisserie system with built-in motor and 18,500 BTU infrared burner
- o Smoker system with 5,000 BTU dedicated burner and drawer for wood chunks
- o 770 sq. in. actual grilling area
- o 3-position warming racks stores up and out of the way when rotissing
- o Dual integrated 20,000 BTU side burner with recessed, sealed top and stainless steel cover
- o User-friendly push-button ignition with sealed 110v AC power source
- o Optional infrared Sear Zone™ and refrigerated base cabinet

| AVAILABLE MODELS | | With Sear Zone™ |
|------------------|---------------------------------|-----------------|
| ALXE-56 | 56" Deluxe Built-in Grill | ALXE-56SZ |
| ALXE-56C | 56" Deluxe Cart Model Grill | ALXE-56SZC |
| ALXE-56R | 56" Deluxe on Refrigerated Cart | ALXE-56SZR |

Available in LP or Natural Gas

Built-in Model



Cart Model



Refrigerated Cart Model



SEAR ZONE™ LAMB CHOPS WITH MINT CHIMICHURRI

Alfresco Original Recipe by Skylar Thomson

Yield: 6 servings

Ingredients

2 large garlic cloves peeled
1 small bunch of fresh mint
1 small red Thai chili
(two if you are feeling brave)
Zest and juice of one lemon
2 teaspoon coarse sea salt, divided
1 teaspoon ground black pepper
2 tablespoons extra-virgin olive oil
6 lamb chops, about 3/4" to 1" thick
2 bunches of rosemary for V-grate
6 cloves of garlic, peeled for V-grate

Preparation

Add the garlic, mint, Thai chili, lemon zest, lemon juice, and salt into a food processor. Pulse until combined, then pour in olive oil and pulse until a thick paste forms. Set aside.

Drizzle both sides of the lamb chops with olive oil, and sprinkle with salt and pepper.

Line the V-grate section of your Alfresco grill with rosemary and garlic cloves, and turn to high heat until the herbs begin to smoke. Now add the chops on top of the smoking herbs and sear for about 3 minutes. Flip the chops over and cook for another 2 minutes for medium-rare, and 3 1/2 minutes for medium.

Remove the chops from the grill. Allow to rest for 5 minutes. Serve on a platter or board with the mint Chimichurri spooned over the top.



42" LXE GRILL

- o Three 18-SR stainless steel main burners producing 82,500 BTUs
- o Integrated rotisserie system with built-in motor and dual 18,500 BTU infrared burner
- o Smoker system with 5,000 BTU dedicated burner and drawer for wood chunks
- o 770 sq. in. actual grilling area
- o 3-position warming rack stores up and out of the way when rotissing
- o Dual integrated high-intensity halogen work lights
- o User-friendly push-button ignition with sealed 110v AC power source
- o Optional infrared Sear Zone™ and refrigerated base cabinet

| AVAILABLE MODELS | | With Sear Zone™ |
|------------------|-----------------------------------|-----------------|
| ALXE-42 | 42" Built-in Grill | ALXE-42SZ |
| ALXE-42C | 42" Cart Model w/2 Doors | ALXE-42SZC |
| ALXE-42CD | 42" Cart Model w/2 Drawers | ALXE-42SZCD |
| ALXE-42R | 42" Cart Model Refrigerated Grill | ALXE-42SZR |

Available in LP or Natural Gas



Built-in Model



Cart Model



Refrigerated Cart Model

Deluxe Cart Model

36" LXE GRILL

- o Three 18-SR stainless steel main burners producing 82,500 BTUs
- o Integrated rotisserie system with built-in motor and 18,500 BTU infrared burner
- o Smoker system with 5,000 BTU dedicated burner and drawer for wood chunks
- o 660 sq. in. actual grilling area
- o 3-position warming rack stores up and out of the way when rotissing
- o Dual integrated high-intensity halogen work lights
- o User-friendly push-button ignition with sealed 110v AC power source
- o Optional infrared Sear Zone™

| AVAILABLE MODELS | | With Sear Zone™ |
|------------------|---------------------------------|-----------------|
| ALXE-36 | 36" Built-in Grill | ALXE-36SZ |
| ALXE-36C | 36" Cart Model Grill w/2 Doors | ALXE-36SZC |
| ALXE-36CD | 36" Cart w/2 Drawer Model Grill | ALXE-36SZCD |

Available in LP or Natural Gas

Built-in Model



Cart Model



Deluxe Cart Model



30" LXE GRILL

- o Two 18-SR stainless steel main burners producing 55,000 BTUs
- o Integrated rotisserie system with built-in motor and 15,000 BTU infrared burner
- o Smoker system with 5,000 BTU dedicated burner and drawer for wood chunks
- o 542 sq. in. actual grilling area
- o 3-position warming rack stores up and out of the way when rotissing
- o Dual integrated high-intensity halogen work lights
- o User-friendly push-button ignition with sealed 110v AC power source
- o Optional infrared Sear Zone™

| AVAILABLE MODELS | | With Sear Zone™ | All Infrared |
|------------------|--------------------------------|-----------------|--------------|
| ALXE-30 | 30" Built-in Grill | ALXE-30SZ | ALXE-30IR |
| ALXE-30C | 30" Cart Model Grill w/2 Doors | ALXE-30SZC | ALXE-30IRC |
| ALXE-30CD | 30" Cart w/Drawer Model Grill | ALXE-30SZCD | ALXE-30IRCD |

Available in LP or Natural Gas

Built-in Model



Cart Model



Deluxe Cart Model



DROP-IN GRILL ACCESSORIES

Alfresco offers the Industry's largest selection of grill-transforming options

STEAMER / FRYER / PASTA COOKER

Drops into any Alfresco grill to blanch, steam, fry, or boil.
All stainless steel. Model: AG-SF

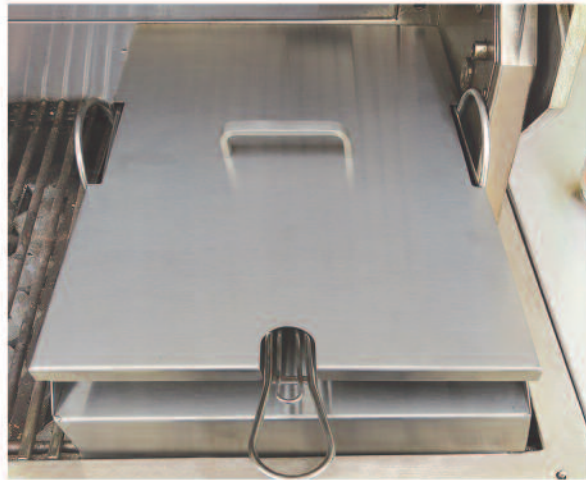

SOLID FUEL INSERT

Transform your Alfresco gas grill into a wood-source cooking system. Simply drop the special designed insert into the grill, and fill with your favorite wood, lump charcoal, or other solid fuel for real wood-cooking flavor. Model: SFI-POD





COMMERCIAL GRIDDLE

3/16" solid stainless steel plate with side and back splash.
For teppanyaki, fajitas, breakfast, or juicy burgers.
Side Burner Model: AGSB-G,
Grill Model: AGSQ-G



INDIRECT ROASTING POD

Turn your grill into an amazing roasting oven with Alfresco's indirect roasting pod. Holds drip pan for self-basting, bringing out true slow-roast flavor. Use adjacent burner(s) to create convection heat, or smoke-and-roast using the smoke and herb infusion system.
Model: AIC-POD



FOOD WARMER/ STEAM TABLE

Features three removable stainless steel food pans with covers, and a slide-out drawer for Sterno-type fuel canisters.
Built-in Model: AXEFW,
Cart Model: AXEFWC



18 EXCITING COOKING STYLES IN ONE GRILL!

1. Grill
2. Infrared Steakhouse Broiling
3. Rotiss
4. Smoketiss
5. Cold Smoke
6. Indirect Roast
7. Indirect Bake
8. Indirect Smoke & Roast
9. Minute Neopolitan Pizzas
10. Smoke
11. Steam
12. Fry
13. Pasta Cooking
14. Log & Lump Charcoal Grilling
15. Smoke & Sear
16. Herb Infuse
17. Griddling
18. Decadent fried desserts

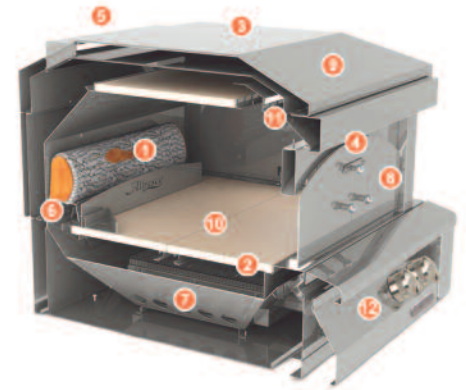

Countertop Pizza Oven Plus



Pizza Prep Cart



Pizza Basic Cart

PIZZA OVEN PLUS

Pizza Oven Plus preheats in 16 min. and can reach over 1,000° F allowing you to roast, bake, iron-skillet sear, and of course, cook perfect three minute Neopolitan pizzas.

1. Fireplace-like gas log absorbs and radically accelerates preheat time as it distributes heat up to the ceramic ceiling slab for intense top-down heat
2. 3/4" thick high-quality ceramic slab hearth and ceiling for even intense radiating heat.
3. All 304 18-8 heli-arc welded stainless steel
4. Full 8.5" high opening
5. Countertop rear exhaust
6. 20,000 BTU tube-log burner
7. High-tech 20,000 BTU high-heat ceramic infrared hearth burner
8. Removable hinges/doors
9. Double-walled removable top
10. 456 sq. in. of cooking space
11. Halogen oven light
12. Alfresco's exclusive natural air-cooling plenum keeps control panel cool to the touch

AVAILABLE MODELS

| | |
|--------------|-----------------------|
| AXE-PZA-BI | Built-in Model |
| AXE-PZA | Countertop Model |
| AXE-PZA-CART | Basic Cart Model |
| AXE-PZA-PPC | Pizza Prep Cart Model |

Available in LP or Natural Gas



PREP & PLATING CENTER

Real restaurant style pizza prep and plating center.

- Plate shelf for storing plates, pizza pans, spices and other necessities
- Convenient removable plastic cutting board
- Ice-cooled pan rail with NSF food pans for pizza toppings and other condiments
- Also ideal as a raw bar, martini, and wine rail
- The ultimate in convenience

AVAILABLE MODELS

APS-30PPC

VERSA POWER

- Power and versatility at your fingertips with numerous options
- Unique individually controlled double burner system
- Brass center burner adjusts from 400 to 20,000 BTUs
- Stainless steel outer tube burner adjusts from 5,000 to 45,000 BTUs
- 5/16" diameter stainless steel spider grate with removable trivet
- The perfect complementary appliance to complete your outdoor kitchen
- Ideal for use as European French Top

AVAILABLE MODELS

| | |
|-----------|--------------------|
| AXEVP | Built-in Model |
| AXEVP-C | Cart Only |
| AXEVP-WOK | Commercial Wok |
| AXEVP-TG | Teppanyaki Griddle |
| AXEVP-T10 | Pot Filler |

Available in LP or Natural Gas



Simmer delicate sauces at a low 400 BTU



Center burner adjusts from 400 to 20,000 BTU



Outer burner adjusts from 5,000 to 45,000 BTU



Both burners yield an unprecedented 65,000 BTU

The versa power cooking system is the perfect complementary appliance to complete your outdoor kitchen



Built-in Model



The Versa Power Cart (*sold separately*) is perfect for tailgating and cooking on location.



The Versa Power handles the smallest of saucepans, allowing for unrivaled efficiency and economy. From Hollandaise and white wine sauces, to cream and mustard sauces, you have the control to make the perfect condiment to your perfect open-air meal.



The unsurpassed capacity of the Versa Power accommodates stock pots up to 100 quarts. Add to this the optional cart, and you have the perfect cooker for tailgating and other mobile situations.



COMMERCIAL WOK

Remove the center ring grate from the Versa Power and drop in a true commercial round bottom wok. 21.5" diameter.



TEPPANYAKI GRIDDLE

3/16" solid stainless steel plate with back and end splashes. Ideal for multiple cooking styles. Great for Japanese Teppanyaki cooking, breakfast griddling, Mexican grill, Kamal Tortilla cooking, and even works well as a plate warmer to keep those steaks sizzling when served.



POT FILLER

Install into island next to Versa Power for convenient filling of large pots. The tower is adjustable from 10" to 14" in height with a double joint spout.



VERSA POWER SEAFOOD PAELLA

Alfresco Original Recipe by Skylar Thomson

Ingredients

4 tablespoons olive oil
1/4 pound large shrimp (*peel, de-vein*)
1/4 pound of mussels
1/4 pound of small clams
6 oz. hard chorizo sliced
1 large onion, roughly chopped
4 cloves garlic, sliced
1/4 cup white wine
3 cups long-grain rice
1 teaspoon paprika
1 teaspoon crushed chili flakes
1 teaspoon of saffron
1 bell pepper finely chopped
4 cans reduced-sodium chicken broth
Coarse salt and ground pepper
Italian parsley for garnish

Preparation

In a standard paella pan or 12-inch sauté pan, heat 2 tablespoons oil over medium-high heat. Cook shrimp until it is pink on both sides, about 4 min. Transfer to a plate and set aside.

Add remaining 2 tablespoons olive oil and chorizo to the pan and cook over high heat until beginning to brown. Add onion, bell pepper, chili flakes, paprika, salt, saffron, and cook until translucent. Now add garlic, mussels, clams, and white wine and cook until wine reduces, and mussels and clams open. Add rice and stir to coat, until rice is translucent. Add chicken broth and any salt and pepper to taste.

Stir the entire mixture carefully, bring to a boil. Reduce heat to a simmer and cover. Cook until rice is tender and has absorbed most of the liquid (20-25 min.). Stir in shrimp, making sure it's just pink and turn up the heat to high for 3 min. so the rice gets crisp on the bottom of the pan, but not burnt. Garnish with parsley, red pepper flakes, and serve.



SIDE BURNERS

- Restaurant power and control
- Dual side burner - all commercial stainless steel with heli-arc welded seams
- Two 20,000 BTU burners with electronic ignition
- Recessed top and stainless steel cover for protection from wind and elements
- Sear Zone burner - reaches 1500° F in four minutes and cooks 50% faster with virtually no flare-ups
- Available as built-in unit, or mounts to cart model grills in place of side tray



Stand-alone dual side burner



Stand-alone side Sear Zone™ burner

AVAILABLE MODELS

| | |
|----------|---------------------|
| AXESB-2 | Built-in Model |
| AXESB-2C | Hangs on Grill Cart |
| AXESZ | Sear Zone™ |
| AGSB-G | Commercial Griddle |
| AG-WOK | Commercial Wok |
| AG-WR | Wok Ring |

Available in LP or Natural Gas



COMMERCIAL GRIDDLE

3/16" solid stainless plate with side and back splash.
Great for teppanyaki, fajitas, breakfast, or juicy burgers.



COMMERCIAL WOK AND WOK RING

For use on the side burner or on the grill.

REFRIGERATION

- o All stainless steel construction inside and out
- o 1,000 BTU all-weather refrigeration system for deep cooling
- o Certified to NSF standards (National Sanitation Foundation)
- o Temperatures uniquely adjustable from 27° to 56° F
- o Commercial fan-driven fin evaporator cooling inside
- o Fully front-breathing
- o Commercial polyurethane shot-in-place foam insulation
- o Flash Recovery System quickly cools internal temperature
- o User-friendly digital control with lighted display
- o Door-activated internal lighting

AVAILABLE MODELS

| | |
|---------|--|
| ARXE-42 | 7.25 Cu. Ft. Under-Grill Refrigerator |
| URS-1XE | 7.25 Cu. Ft. Built-in and Freestanding One Door Refrigerator |
| ACK | Caster Kit To Create Freestanding Refrigerator |
| AKK | Optional Keggerator Kit for URS-1XE |
| ARDI | Versa Chill Built-in Model |
| ARDI-C | Versa Chill Freestanding Cart Model |



7.25 CU. FT. UNDER-GRILL REFRIGERATOR

Restaurant-inspired design offers great ergonomics and versatility. Door section features adjustable stainless steel wire shelf. Two drawer section designed for marinating and includes removable NSF food pans. Available integrated to the 42" and 56" cart model grills.

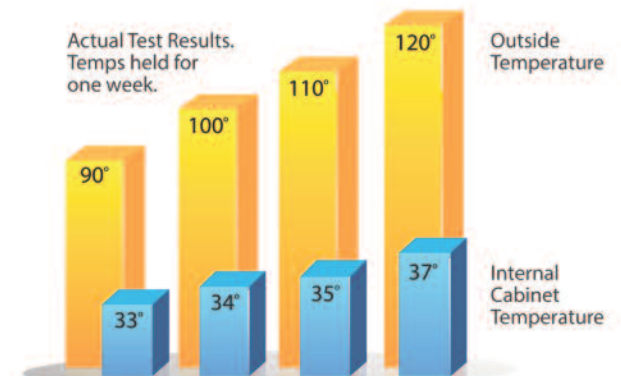

Only Alfresco refrigeration can maintain extremely cold internal temperatures in very hot outside temperatures.
(results may vary due to conditions)



7.25 CU. FT. ONE DOOR REFRIGERATOR

- o 2 removable/adjustable stainless steel shelves
- o Field-reversible door.
- o Converts to Keggerator in seconds
- o Digital control with lighted display
- o Commercial fan-driven fin coil cooling creates constant horizontal vortex of air



KEGGERATOR

Conversion kit includes: Alfresco-built stainless steel tower with faucet, CO² tank, beer lines with quick disconnect, pressure gauges, and drip tray with anti-splash grate.

VERSA CHILL COUNTER TOP REFRIGERATOR

Real commercial top-access cooler features state-of-the-art frost wall technology.

- o 1,200 BTU all-weather refrigeration system
- o Insulated tilt-up and removable stainless steel cover
- o Commercial polyurethane shot-in-place foam insulation
- o Three removable NSF food pans
- o Slideable intermediate stainless steel wire shelf
- o 1" brass drain for easy clean up
- o 101 lb. ice capacity



Incredibly Versatile! Great for use as a bottle cooler, mug froster, martini freezer, fresh fruit smoothie and juice center, deli-prep center, burger topping/condiment bar, salsa bar, bottle/ice bath, wine cooler, Keggerator, and dessert bar.



Libation,
smoothie juice bar



All provision
and glass chiller



Ice/bottle bath



Keggerator



Cutaway view showing frost wall design

ADD A BUILT-IN UNIT TO YOUR ISLAND FOR SUPER CONVENIENT COLD STORAGE

1. Cold pans for perishable condiments
2. Thermostat-controlled temperature from the teens to 56° F
3. Half-width mid-depth shelf for lower level access
4. Exclusive commercial frost wall technology
5. Frost wall creates an Arctic blanket of frigid cold air

ISLAND ACCESSORIES



ELECTRIC WARMING DRAWER

30" wide drawer with electronic temperature control. Includes four convenient removable stainless steel food pans each with removable stainless steel lid. Model: AXEWD-30



PLATING AND GARNISH CENTER

Restaurant-inspired plating station with food pans, carving board, and plate storage below. Create food presentations like a professional. Model: APS-30P



PREP AND WASTE CHUTE

Sliding poly cutting board covers trash chute. Model: APWC



30" Pantries



42" Pantries

SEALED DRY STORAGE PANTRY

Store dry goods, cookware, tools, and more in a complementary sealed environment, safe from weather and pests. Four sizes with interior drawers and shelf. Sealed pantries feature drawers and adjustable shelves. Foam gasket on cabinet face makes for a tight seal, and a new integral rain gutter diverts water around and away from the cabinet. 30" Pantries: Low Profile, Model: AXEDSP-30L. High Profile AXEDSP-30H. 42" Pantries: Low Profile, Model: AXEDSP-42L. High Profile AXEDSP-42H.



PREP AND HAND SINK

All stainless steel design with hot and cold faucet, removable cutting board, and C-fold towel dispenser. Model: ASK-T



17" SINGLE ACCESS DOOR
Left Door: AXE-17L
Right Door: AXE-17R



23" SINGLE ACCESS DOOR
Left Door: AXE-23L
Right Door: AXE-23R



DOUBLE ACCESS DOORS
30" Wide Doors: AXE-30
36" Wide Doors: AXE-36
42" Wide Doors: AXE-42



30" STORAGE DRAWER
Oversize for large pans
Model: AXE-30DR



32" COMBO DOOR & DRAWERS
Door on Left: AXE-DDC-L
Door on Right: AXE-DDC-R



STORAGE DRAWERS
2 Drawer Unit: AXE-2DR



STORAGE DRAWERS
3 Drawer Unit: AXE-3DR



THREE DRAWER/ PAPER TOWEL HOLDER
AXE-3DRTH



DOOR/DRAWER COMBO
AXE-DDR-L
(Handle on left)
AXE-DDR-R
(Handle on right)



DOOR/ PAPER TOWEL HOLDER
AXE-DTH-L
(Handle on left)
AXE-DTH-R
(Handle on right)



TRASH CENTER DRAWER
Single Bin: AXE-TC
Double Bin: AXE-TC2D
Includes durable plastic receptacle(s)



PAPER TOWEL HOLDER
For standard paper towel rolls: AXE-TH



ACCESSORY SPEED RAILS
14" Wide Rail: RAIL-14
19" Wide Rail: RAIL-19



Doors feature multiple mounting options and internal storage unit.



Drawers pull out on German engineered smooth gliding full-extension slides.

VERSA SINKS AND BEVERAGE CENTERS

Versa sinks are one of the most versatile appliances for your outdoor kitchen. Transforms from a sink to an ice bin to a beverage center to a wash-up center in seconds.



14" VERSA SINK AND BEVERAGE CENTER

- Sink basin size: 11"W x 21"D x 8 1/4" H
- 3" basket drain with stopper accommodates disposer
- Full ice capacity: 32 lbs.
- 1" foam insulation on all sides and bottom



INCLUDES:

- Separate stainless steel ice pan for sink and ice combo use
- Hang-on-front bottle speed rail (3) bottle capacity
- Sliding stainless steel cover
- Front accessories easily attach on and off for quick reconfiguration of the sink
- Model: AGBC-14



24" VERSA SINK AND BEVERAGE CENTER

- Sink basin size: 19"W x 21"D x 8 1/4" H
- 3" basket drain with stopper accommodates disposer
- Full ice capacity: 60 lbs.
- 1" foam insulation on all sides and bottom



INCLUDES:

- Hang-on-front bottle speed rail (3) bottle capacity
- Bottle opener and towel holder. includes cap catcher.
- Sliding stainless steel cover
- Front accessories easily attach on and off for quick reconfiguration of the sink
- Model: AGBC-24



SENSIBLE UNDER-THE-COUNTER SOLUTION

Save valuable counter space with the under-counter ice drawer and beverage center.

- All stainless steel construction with heavy-duty 150 lb. capacity drawer sides
- Fully insulated housing and drawer face
- Standard components include: NSF 6" deep stainless steel pan which holds 32 lbs. of ice and 4 condiment pans, bottle, and glass storage
- Remove components and use as large ice drawer
- Magnetic rubber gasket and 1" foam insulation
- Model: AXE-ID

Customize your 30" Versa Sink with optional accessories.



30" VERSA SINK

- o Sink basin size: 27"W x 21"D x 8 1/4" H
- o 3" basket drain with stopper accommodates disposer
- o Full ice capacity: 75 lbs.
- o 1" foam insulation on all sides and bottom
- o Wood cutting board
- o Model: AGBC-30



30" VERSA SINK OPTIONAL ACCESSORIES

- o Sliding stainless steel cover
- o Front accessories easily attach on and off for quick reconfiguration of the sink
- o Towel holder. A simple bar for hand towels. Model: TH
- o Speed rail holds bottles for easy access. Comes in two sizes. Model: SPR-LG or SPR-SM



30" BEVERAGE CENTER

- o Serving shelf with light. Model: HS-30
- o Condiment tray to keep small items accessible. Model: CT
- o 6" deep stainless ice pan slides on sink rails. Model: ICE-PAN
- o Bottle opener / towel rack includes cap catcher. Model: BO
- o Speed rail holds bottles for easy access. Comes in two sizes. Model: SPR-LG or SPR-SM
- o 4 bottle wells with tray. Model: BWELL
- o Blender shelf. Model: BS



OPTIONAL 30" VERSA SINK HIGH SHELF

- o High shelf with pot rack and light. True commercial prep. Model: PR-30
- o Middle shelf. Model: MS
- o 4" deep stainless colander for easy draining. Model: COLANDER

DESIGN SOLUTIONS BY ALFRESCO

LET ALFRESCO'S PROFESSIONAL DESIGN TEAM HELP MAKE YOUR OUTDOOR DREAM KITCHEN BECOME A REALITY.

Visit the design services page on our website www.alfrescogrills.com/design-services to learn more about how Alfresco can assist you in planning your outdoor culinary space, and the requirements for this complementary service. Use the online form to provide your local authorized Alfresco Dealer with the necessary information, and the dealer will submit your project to Alfresco's professional design experts.

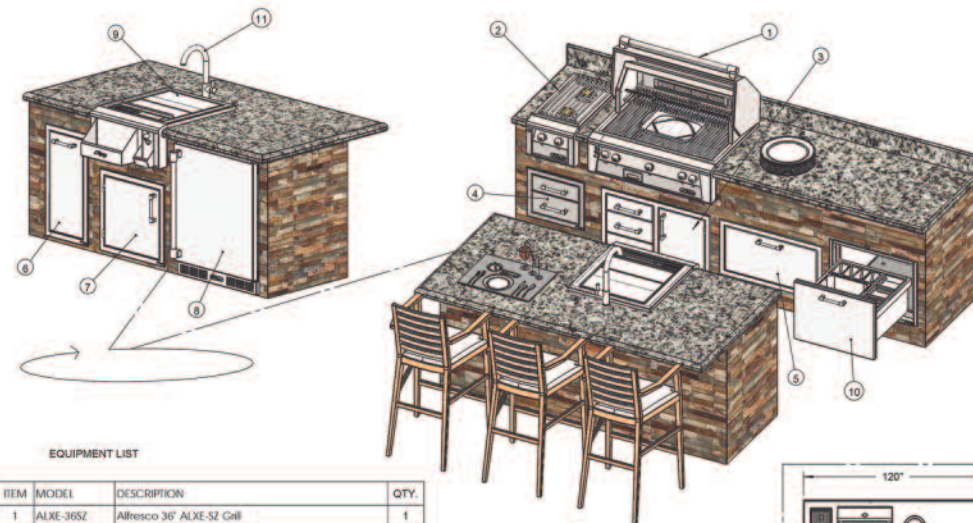

EQUIPMENT LIST

| ITEM | MODEL | DESCRIPTION | QTY. |
|------|------------|---|------|
| 1 | ALXE-36SZ | Alfresco 36" ALXE-SZ Grill | 1 |
| 2 | AXE-SB-2 | Alfresco Dual Side Burner | 1 |
| 3 | AXE-DDC-R | Alfresco Combo Door Plus Drawers | 1 |
| 4 | AXE-2DR | Alfresco 2 storage drawer | 1 |
| 5 | AXE-30DR | Alfresco VersaPower accessory drawer | 1 |
| 6 | AXE-1C | Alfresco slide out trash center | 1 |
| 7 | AXE-23L | Alfresco 23" LT Single Accesses Door | 1 |
| 8 | URS-1XE | Alfresco 7.25 Cu. Ft. One Door Refrigerator | 1 |
| 9 | AGBC-24 | Alfresco 24" Versa Sink - Beverage Center | 1 |
| 10 | AXE-ID | Alfresco Insulated Ice Drawer Beverage Center | 1 |
| 11 | By other's | suggested h/c faucet with spray handle | 1 |

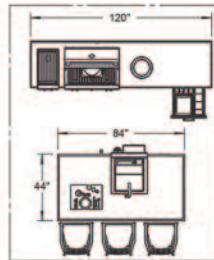

PROVIDE YOUR AUTHORIZED ALFRESCO DEALER WITH THE FOLLOWING:

- o Sketch with overall dimensions showing shape of kitchen and where you would like the grill.
- o Direction indicator (East, West, North, South)
- o Sunset location
- o Location of house relative to kitchen and is kitchen going against the house?
- o Is this a covered area? (if so, it may require outdoor approved ventilator)
- o Location of pool (if one) relative to kitchen
- o Outdoor fireplace (if one)
- o Prevailing wind direction relative to kitchen
- o View relative to kitchen
- o Photos of space (if possible)
- o Gas type: natural or propane



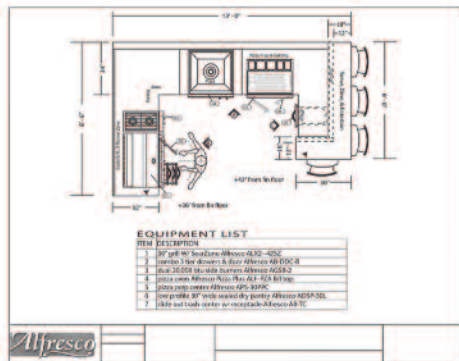
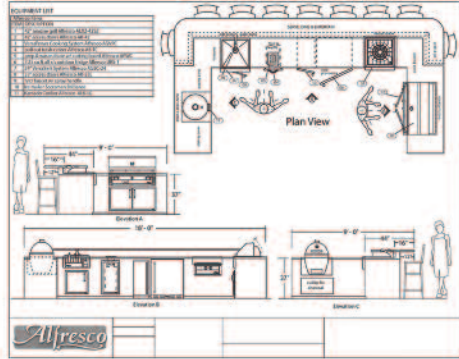

TIPS FOR DESIGNING THE PERFECT OUTDOOR KITCHEN

When designing commercial kitchens, the layout is broken into “zones”, and the location of each zone is strategically placed in order to create harmony in the operation to maximize efficiency. It’s also important that each zone is ergonomically intuitive, having all the essential components confined to the zone, keeping everything in arms reach from point of stance. Alfresco has designed all of the pieces necessary to create a fully-functional outdoor kitchen - one in which any professional chef would feel right at home.

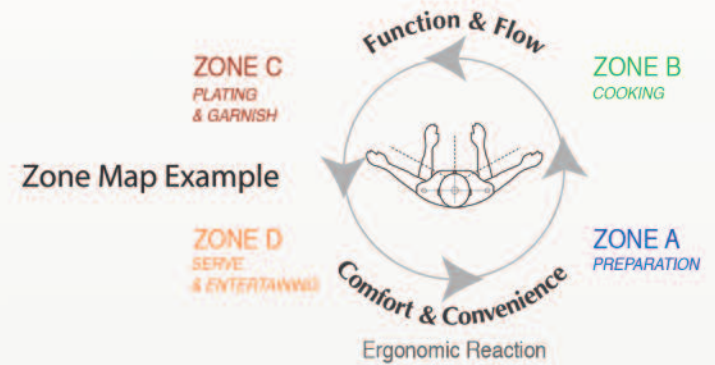

TIPS TO CONSIDER WHEN PLANNING:

- The ideal location for your outdoor kitchen
- Number of guests you would entertain on a normal basis
- Are utilities available at the location (e.g. water, gas, electricity)
- Orientation of outdoor kitchen to house, view, outdoor room, pool
- Orientation to the sunset (be sure seating doesn't face West)
- Prevailing wind direction (avoid positioning grill backside to wind)
- Seating should not be positioned at backside of grill
- Island enclosure material (insulated jacket required)
- Refrigeration, sealed dry storage, and sink eliminates trips in and out
- Let Alfresco's Design Solutions professionals assist in your design
- Remember, your Alfresco dealer is a great source for ideas and knowledge, helping you to create your dream Alfresco kitchen.

Grills & Insulated Jackets

| MODEL | CUTOUT DIMENSIONS | | | | NOTCH N | POWER | | | GAS LINE |
|---------|-------------------|---------|---------|------|------------|-------|-------------|---|-------------|
| | W | D | H | YES | | NO | AMPS | | |
| ALXE-30 | 28-1/2" | 23" | 10-1/4" | 7/8" | ✓ | | 1.44 / 0.91 | ✓ | |
| ALXE-36 | 34-1/2" | 23" | 10-1/4" | 7/8" | ✓ | | 1.44 / 0.91 | ✓ | |
| ALXE-42 | 40-1/2" | 23" | 10-1/4" | 7/8" | ✓ | | 1.44 / 0.91 | ✓ | |
| ALXE-56 | 54-1/2" | 23" | 10-1/4" | 7/8" | ✓ | | 1.44 / 0.91 | ✓ | |
| AIJ-30 | 33-1/4" | 24-5/8" | 11-1/4" | 7/8" | ✓ | | ◆ | ✓ | |
| AIJ-36 | 39-1/4" | 24-5/8" | 11-1/4" | 7/8" | ✓ | | ◆ | ✓ | |
| AIJ-42 | 45-1/4" | 24-5/8" | 11-1/4" | 7/8" | ✓ | | ◆ | ✓ | |
| AIJ-56 | 59-1/4" | 24-5/8" | 11-1/4" | 7/8" | ✓ | | ◆ | ✓ | |

Note 1: All grills require a 1/2" NPT gas connection with 4" WC for natural gas and 10" Wc for liquid propane.

Note 2: All power supplies are 115 VAC-1Ø-60 Hz. GFCI Receptacle recommended.

◆ Note: Power requirement as stated on the corresponding grill (NOT DUE TO THE AIJ JACKET BY ITSELF).

Dimensions and specifications are subject to change without notice. Please visit our website for the latest updates.

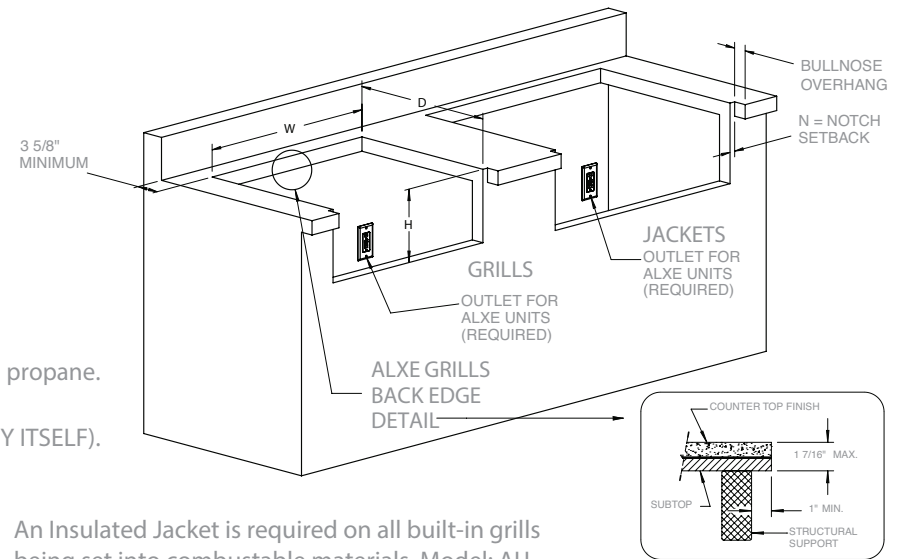

An Insulated Jacket is required on all built-in grills being set into combustible materials. Model: AIJ

Countertop Accessories

| MODEL | CUTOUT DIMENSIONS | | | | NOTCH N | SETBACK S | POWER | | | GAS LINE | WATER LINE | DRAIN LINE |
|--------------|-------------------|---------|---------|--------|------------|--------------|-------|------|------|-------------|---------------|---------------|
| | W | D | H | YES | | | NO | AMPS | | | | |
| AXEVP | 21-1/2" | 22-1/2" | 10-1/4" | 1-3/8" | | | ✓ | | ✓ | | | |
| AXEVP-T10 | 4-1/2" | 4-1/2" | | | 1-5/8" ❖ | | ✓ | | | 3/8" Ⓢ | | |
| AXESB2/AXESZ | 13-1/4" | 23" | 10-1/4" | 1/2" | | | ✓ | | ✓ | | | |
| AXEFW | 13-1/4" | 23" | 10-1/4" | 1/2" | | | ✓ | | | | | |
| ADT-14 | 13-1/4" | 23" | 9-1/4" | 1/2" | | | ✓ | | | 1/2" | 1" | |
| ADT-24 | 23-1/4" | 23" | 10-1/4" | 1/2" | | | ✓ | | | | 1" | |
| ADT-30 | 28-1/2" | 23" | 10-1/4" | 3/4" | | | ✓ | | | 1/2" | 1" + 2" | |
| AGBC-14 | 13-1/4" | 23" | 9-1/4" | 1/2" | | | ✓ | | | 1/2" | 1" | |
| AGBC-24 | 23-1/4" | 23" | 10-1/4" | 1/2" | | | ✓ | | | | 1" | |
| AGBC-30 | 28-1/2" | 23" | 10-1/4" | 7/8" | | | ✓ | | 0.08 | | 1-1/2" | |
| ASK-T | 13-1/4" | 23" | 10-1/4" | 1/2" | | | ✓ | | | 1/2" | 1" | |
| APS-30 | 27-1/2" | 8-3/4" | 9-1/4" | 1-3/8" | | | ✓ | | | | | |
| APS-30P | 27-1/2" | 15-1/4" | 9-1/4" | 1-3/8" | | | ✓ | | | | | |

Note 1: All burners require a 1/2" NPT gas connection with 4" WC for a natural gas and 10" Wc for liquid propane.

Note 2: All water lines are 1/8" compression or 1/2" NPSN unless otherwise shown.

Note 3: All drains sizes as shown are NPSM standard.

Note 4: All power supplies are 115 VAC-1Ø-60 Hz. GFCI receptacle recommended.

❖ Note: The AXEVP-T10 pot filler tower requires a minimum setback as shown (OVER AND UNDER THE COUNTER) from the back wall for proper hardware installation.

Ⓢ Note: The AXEVP-T10 pot filler tower requires a 3/8" compression water line and comes with a 72" long copper line for field connection.

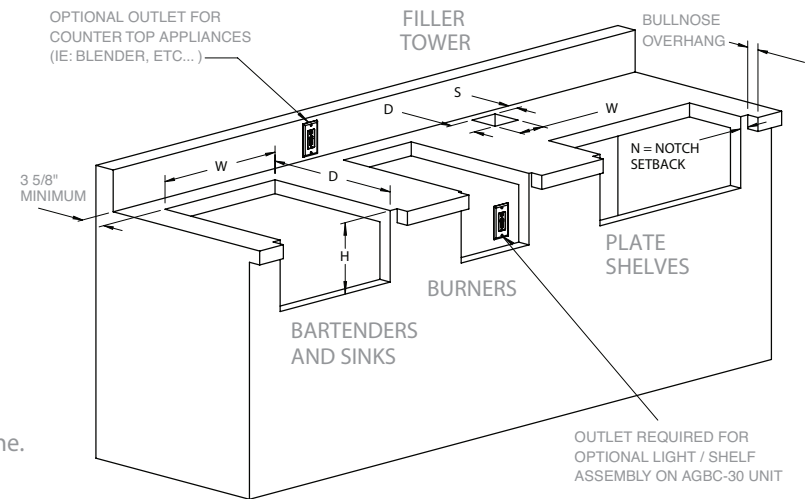

For additional details visit:
www.alfrescogrills.com

Front Mounted Island Accessories, Pantries, Doors, Drawers and Combo Units

| MODEL | CUTOUT DIMENSIONS | | | | SETBACK S | POWER | | | DRAIN LINE |
|---|-------------------|---------|----------|--------|--------------|-------|----|------|---------------|
| | W | H | D | L | | YES | NO | AMPS | |
| AXE-17L / AXE-17R | 13-7/8" | 18-1/2" | ~ | | | | ✓ | | |
| AXE-23L / AXE-23R | 19-7/8" | 18-1/2" | ~ | | | | ✓ | | |
| AXE-30 | 27-1/4" | 18-1/2" | ~ | | | | ✓ | | |
| AXE-42 | 39-1/4" | 18-1/2" | ~ | | | | ✓ | | |
| AXE-DDC-L / AXE-DDC-R | 29-1/4" | 18-1/2" | 19-1/4" | | | | ✓ | | |
| AXE-2DR | 14-3/4" | 12-1/2" | 19-1/4" | | | | ✓ | | |
| AXE-3DR | 14-3/4" | 19-1/4" | 19-1/4" | | | | ✓ | | |
| AXE-30DR | 27-3/4" | 14" | 23-3/4" | | | | ✓ | | |
| AXE-ID | 24" | 17-3/4" | 25-1/8" | | | | ✓ | | 5/8" ⚡ |
| AXE-TC <small>(TRASH ONLY)</small> | 12-1/2" | 26-1/4" | 18-1/2" | | | | ✓ | | |
| AXE-TC2D <small>(TRASH ONLY)</small> | 17-1/4" | 26-1/4" | 24-1/4" | | | | ✓ | | |
| AXE-3DRTH | 14-3/8" | 26-1/4" | 19-1/4" | | | | ✓ | | |
| AXE-DDR | 14-3/8" | 26-1/4" | 19-1/4" | | | | ✓ | | |
| AXE-DTH | 14-3/8" | 26-1/4" | 7-13/16" | | | | ✓ | | |
| AXE-TH | 14-1/2" | 8-1/2" | 7-7/8" | | | | ✓ | | |
| AXEDSP-30H | 28-3/8" | 31-3/4" | 23-3/8" | | | | ✓ | | |
| AXEDSP-30L | 28-3/8" | 19-3/8" | 23-3/8" | | | | ✓ | | |
| AXEDSP-42H | 40-3/8" | 31-3/4" | 23-3/8" | | | | ✓ | | |
| AXEDSP-42L | 40-3/8" | 19-3/8" | 23-3/8" | | | | ✓ | | |
| APWC <small>(CHUTE ONLY)</small> | 6-1/4" | ~ | ~ | 8-1/4" | 4-5/8" ♦ | | ✓ | | |
| AXEWD-30 | 28-1/2" | 10" | 20-1/4" | | | | ✓ | | 3.9 |

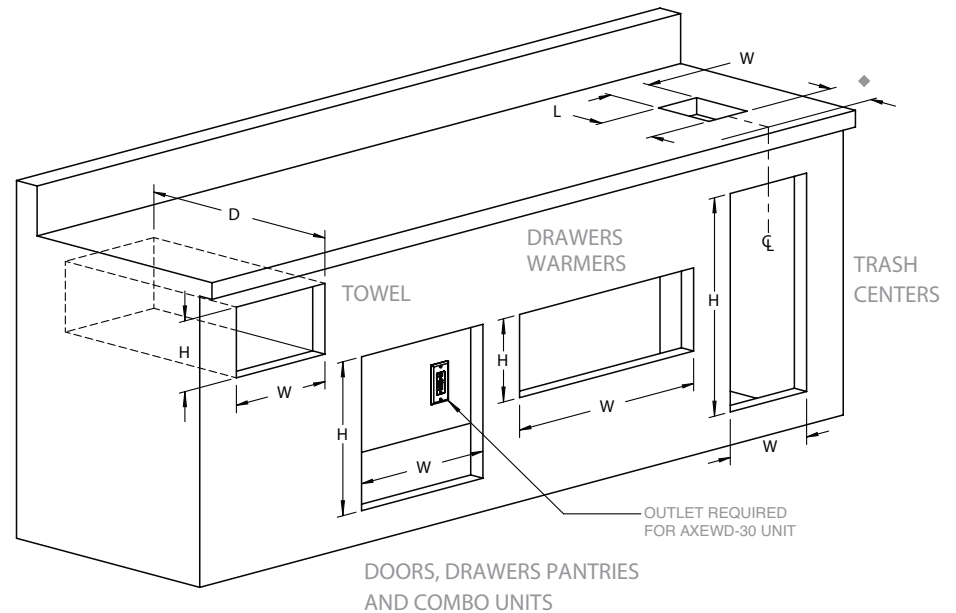

- Note: All power supplies are 115 VAC-1 ϕ -60 Hz. GFCI receptacle recommended.
- ♦ Note: 4 5/8" setback required from cabinet face (NOT BULLNOSE!).
 - ⚡ Note: AB-ID unit comes with 36" plastic drain hose for condensation / ice water waste.

Refrigerator

| MODEL | DIMENSIONS | | | NOTCH N | SETBACK S | POWER | | | DRAIN LINE |
|---------|------------------|---------|---------|------------|--------------|-------|----|------|---------------|
| | W | H | D | | | YES | NO | AMPS | |
| AKK | 2" DIAMETER HOLE | | | | 21-15/16" ♦ | | ✓ | | |
| ARDI | 23" | 32" | 23" | 13/16" | | ✓ | | 5.7 | 1" ⚡ |
| ARXE-42 | 42-1/2" | 21-3/4" | 23-1/4" | | 2" ♦ | ✓ | | 2.9 | |
| URS-1XE | 28-1/2" | 35" | 23-3/8" | | | ✓ | | 2.8 | |

- Note: All power supplies are 115 VAC-1 ϕ -60 Hz. GFCI receptacle recommended.
- ♦ Note: Setback measured from cabinet front (NOT BULLNOSE!).
 - ⚡ Note: Drain size is NPSM-floor drain in lieu of wall mount is acceptable.
 - ♦ Note: Setback minimum distance from floor to accommodate ARXE-42 perimeter flange.

